

デッキ部平面図 (根太)

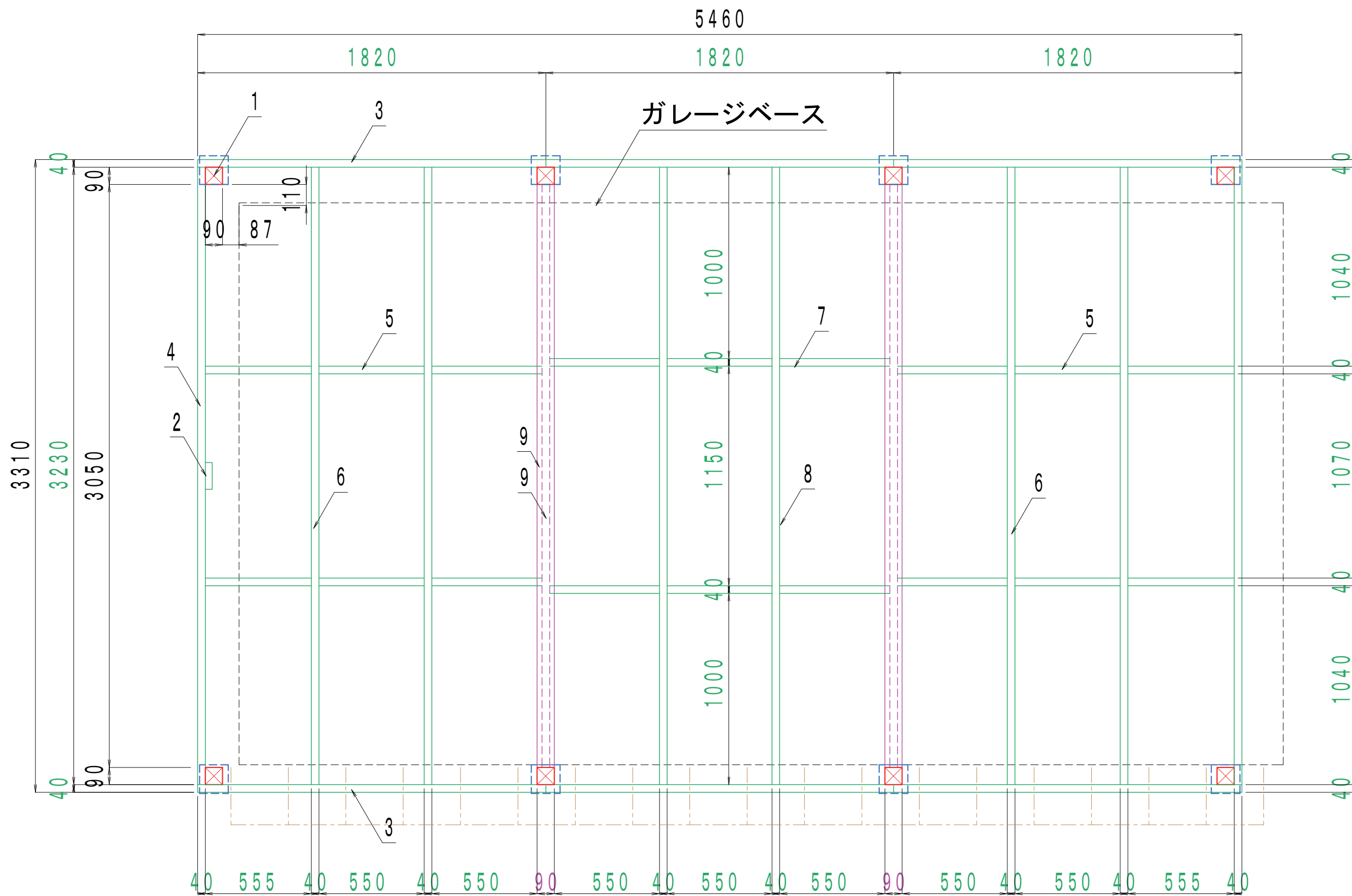

デッキ部平面図 (床材)

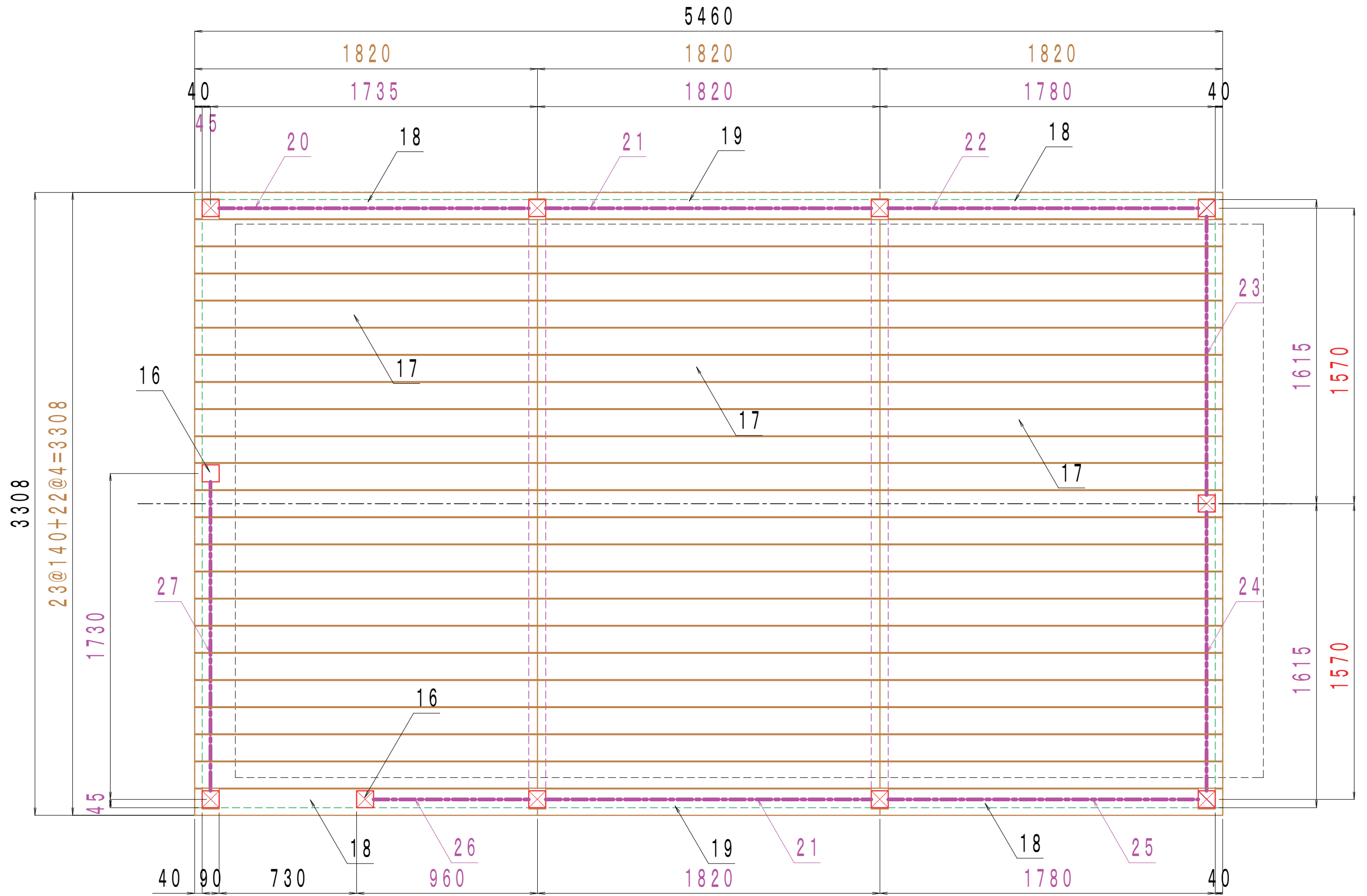

デッキ部側面図

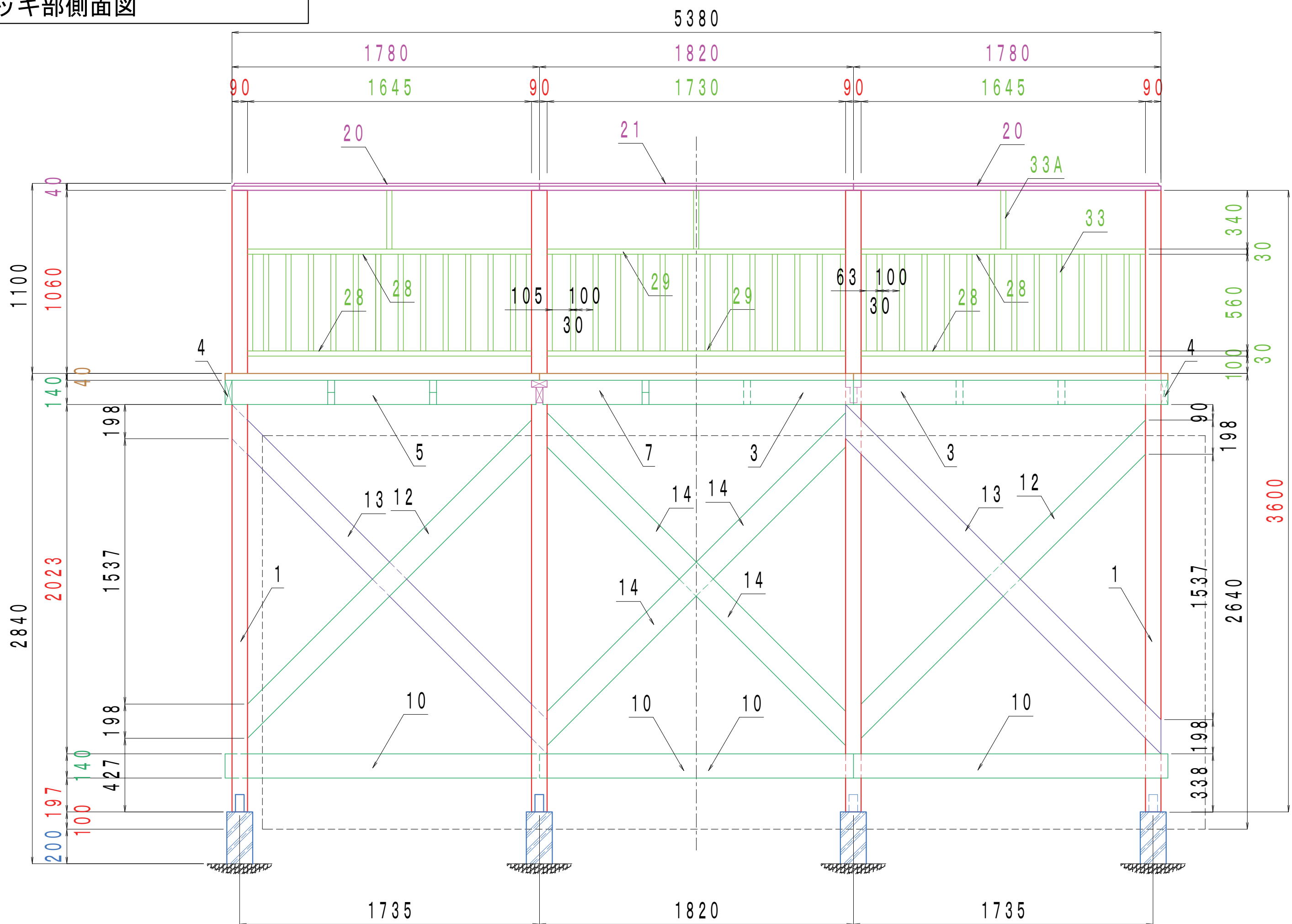

デッキ部断面図

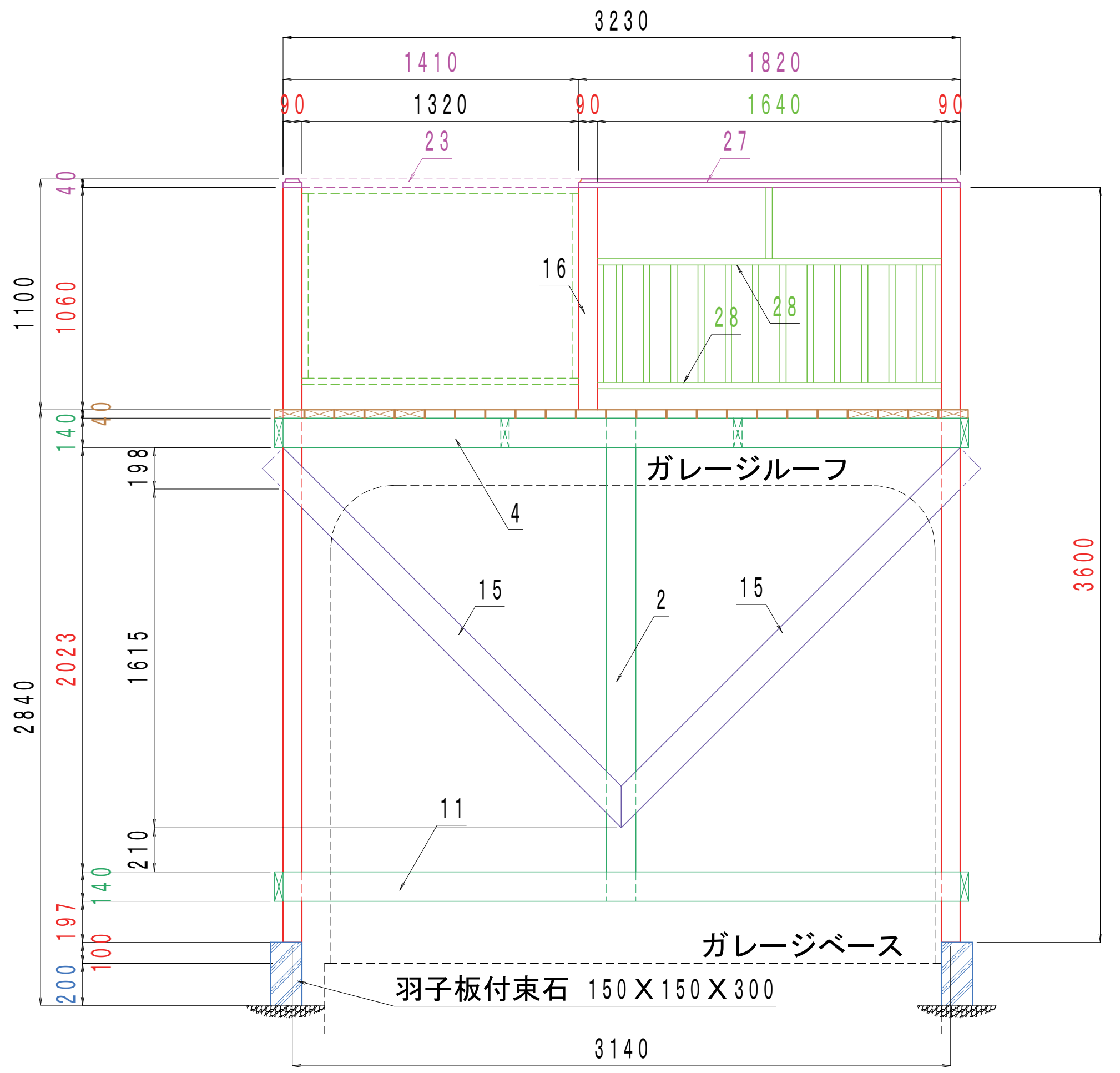
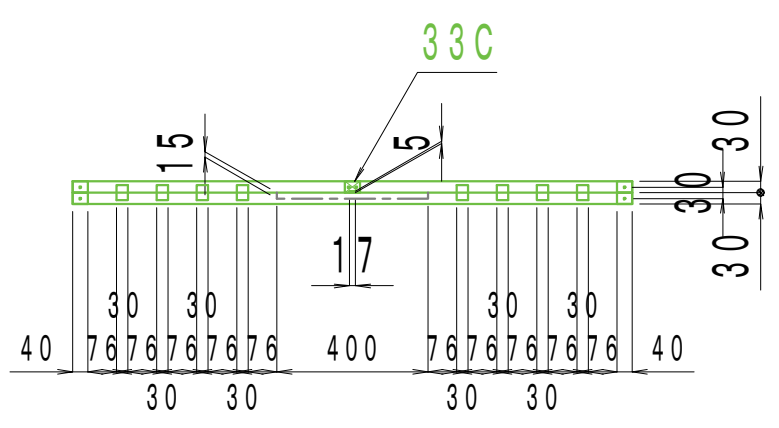
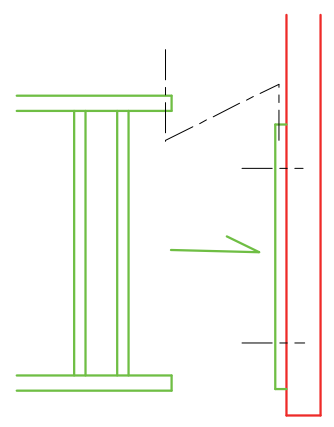
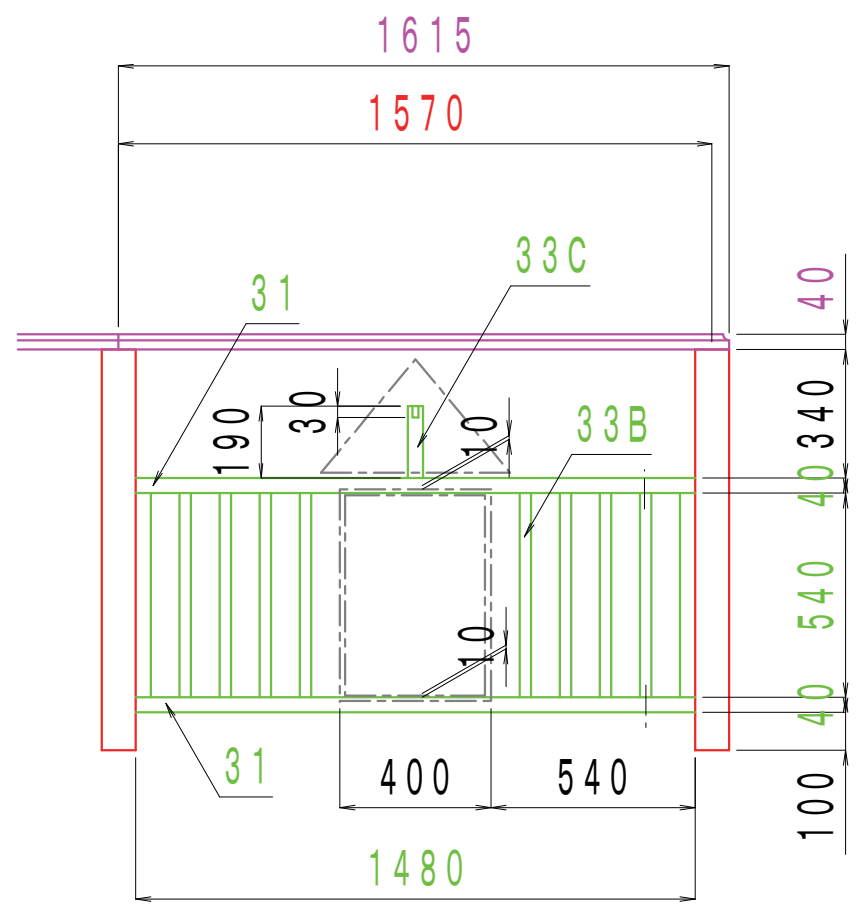

ガレージルーフ

ガレージベース

羽子板付束石 150 X 150 X 300

3600

デッキ部加工図 (柱・根太)

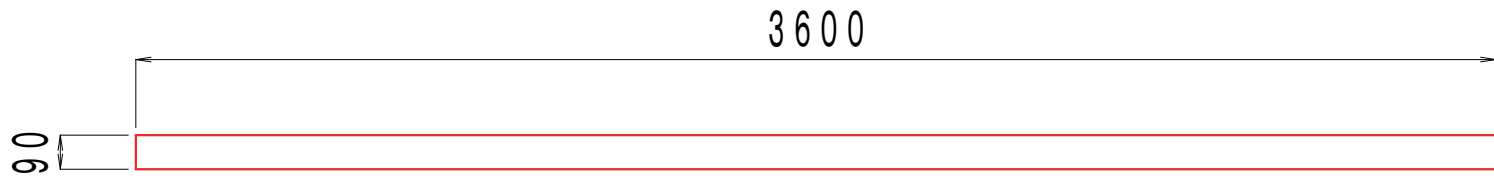

1: 90×90×3600 - 8 (4x4 3600) S

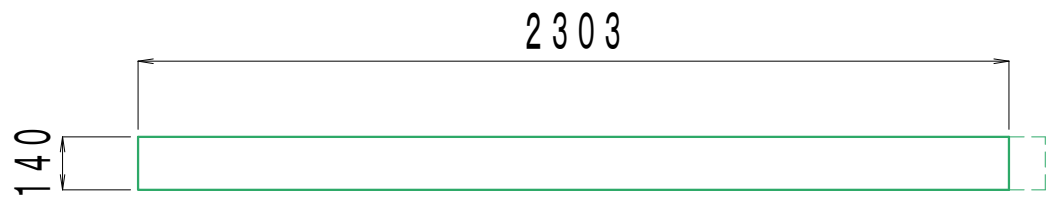

2: 40×141×2303 - 1 (2x6 2400) S

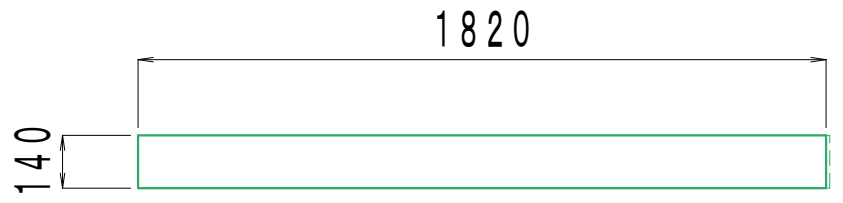

3: 40×141×1820 - 6 (2x6 1830) E

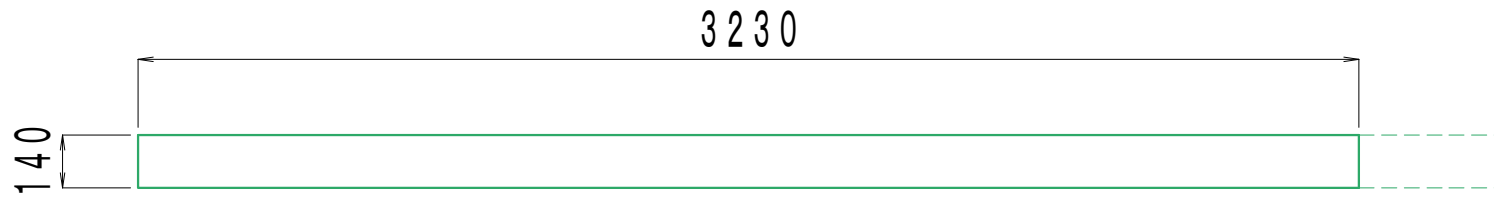

4: 40×141×3230 - 2 (2x6 3600) S

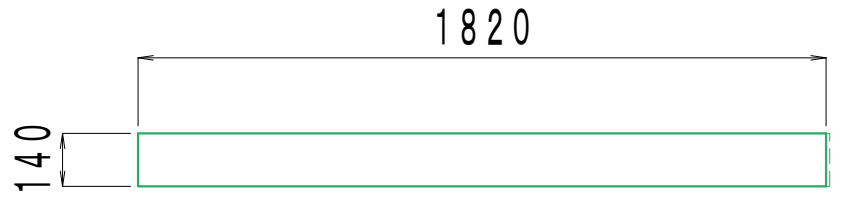

10: 40×141×1820 - 6 (2x6 1830) E

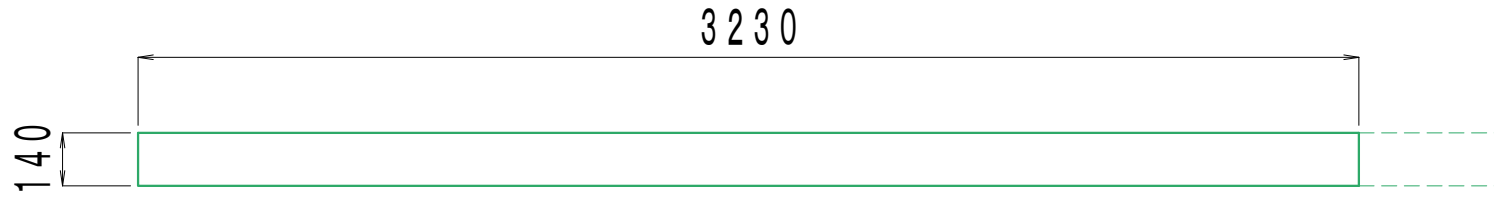

11: 40×141×3230 - 1 (2x6 3600) S

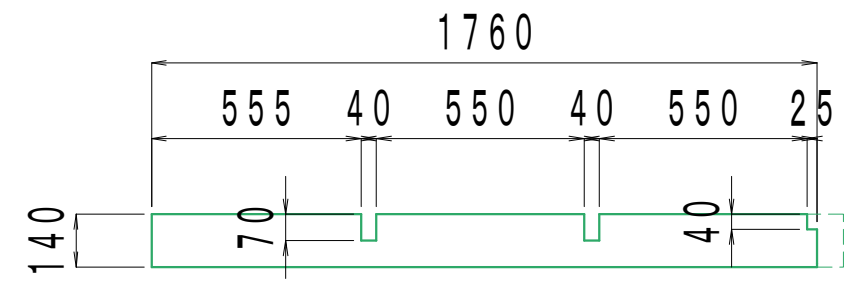

5: 40×141×1760 - 4 (2x6 1830) E

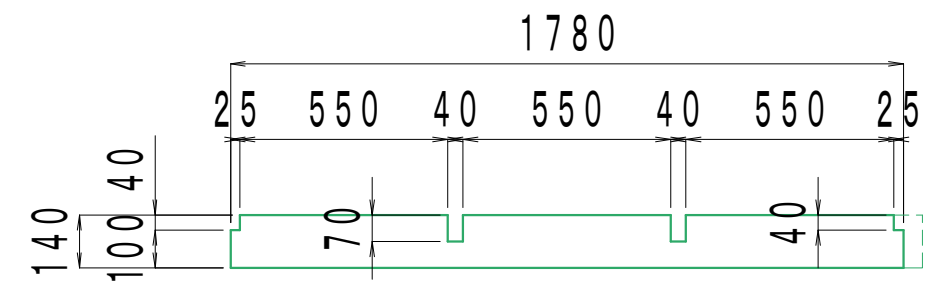

7: 40×141×1780 - 2 (2x6 1830) E

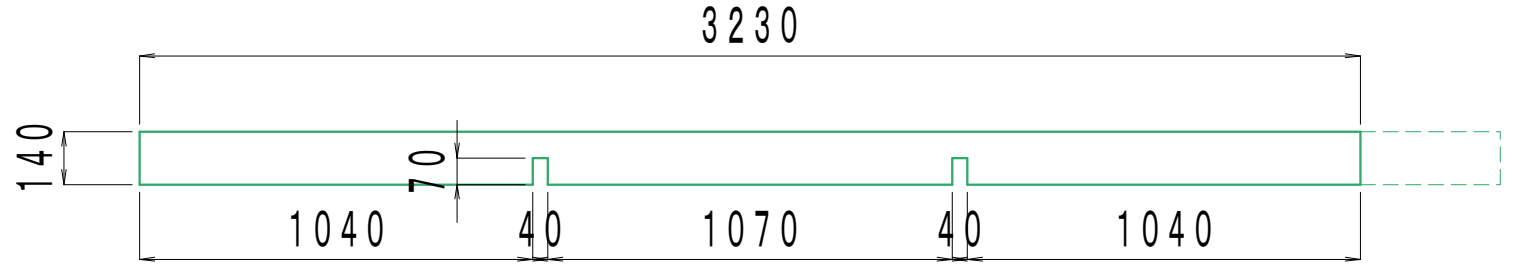

6: 40×141×3230 - 4 (2x6 3600) S

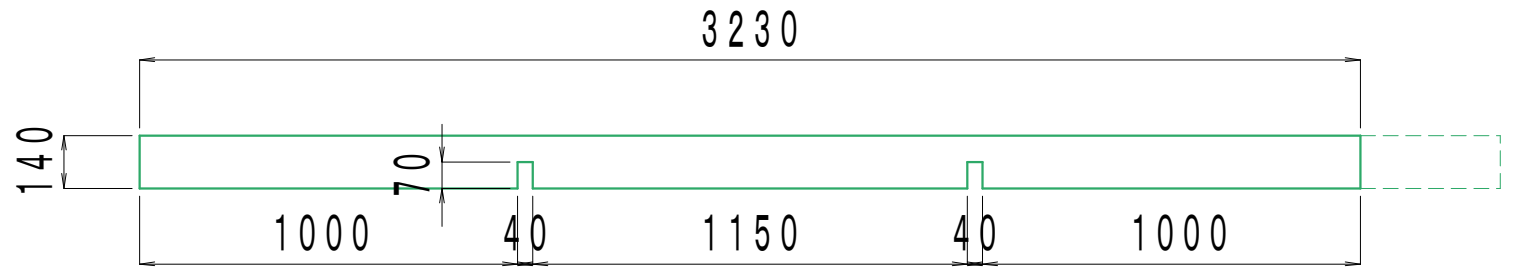

8: 40×141×3230 - 2 (2x6 3600) S

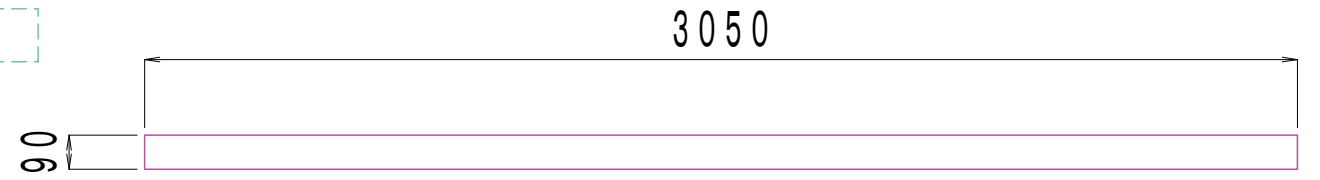

9: 40×90×3050 - 4 (2x4 3048) E

デッキ部加工図 (筋交・床材)

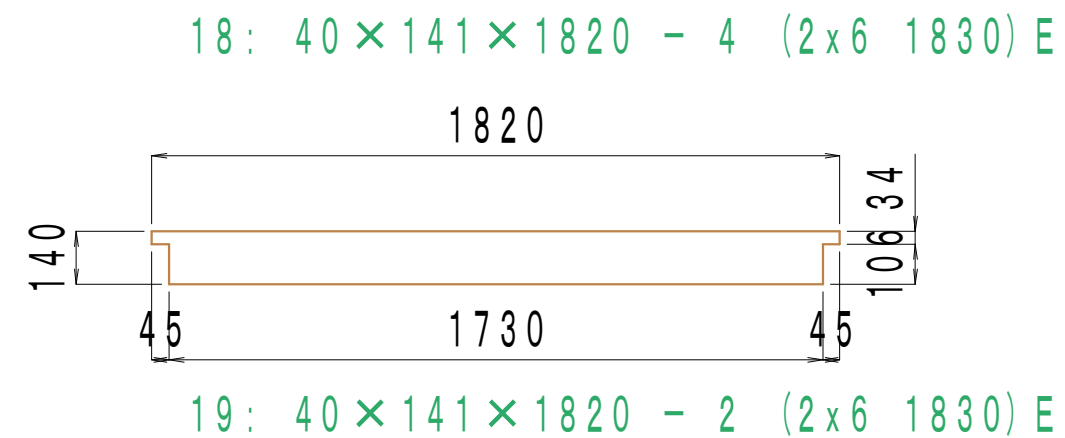
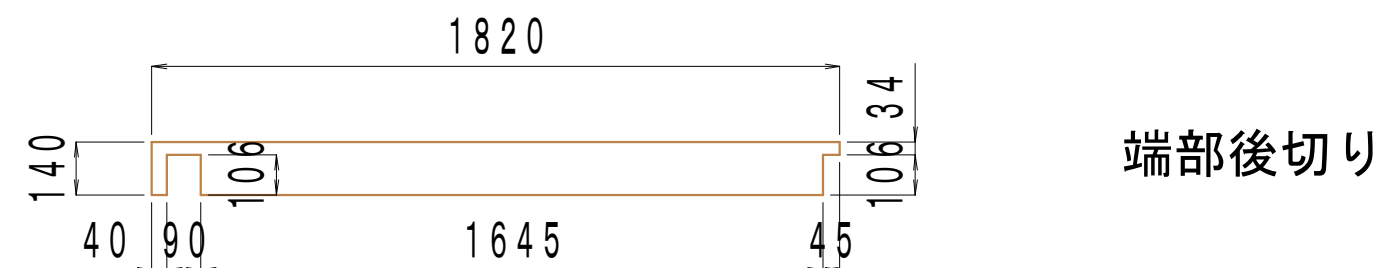
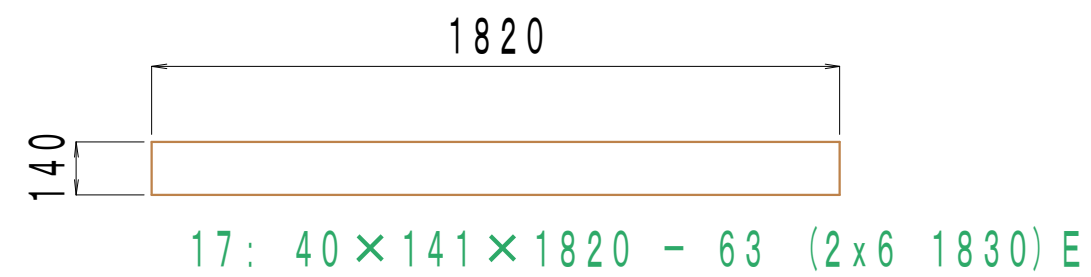
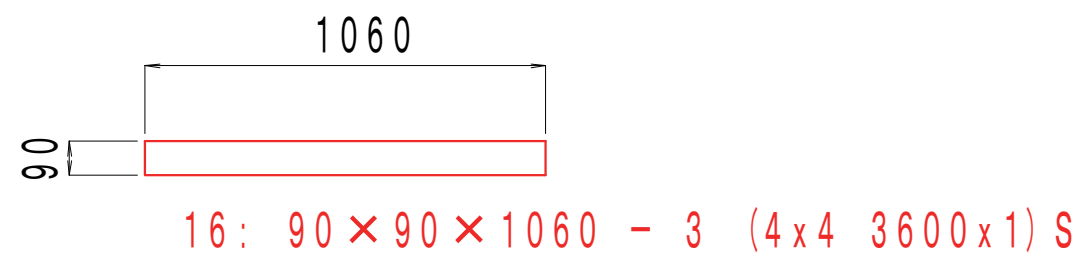
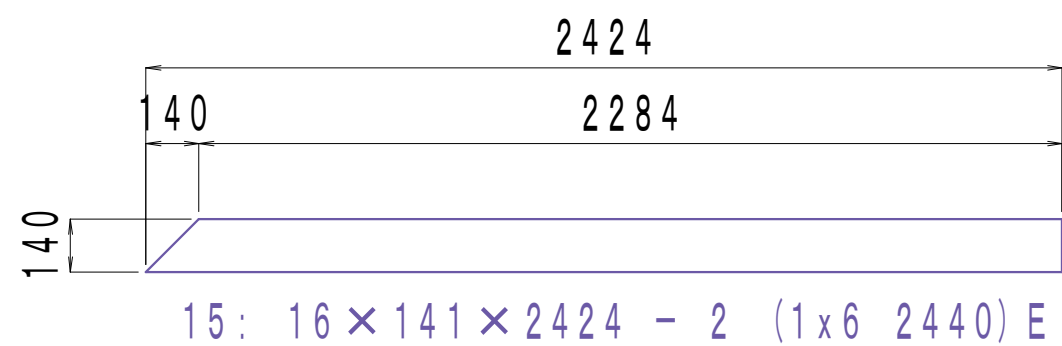
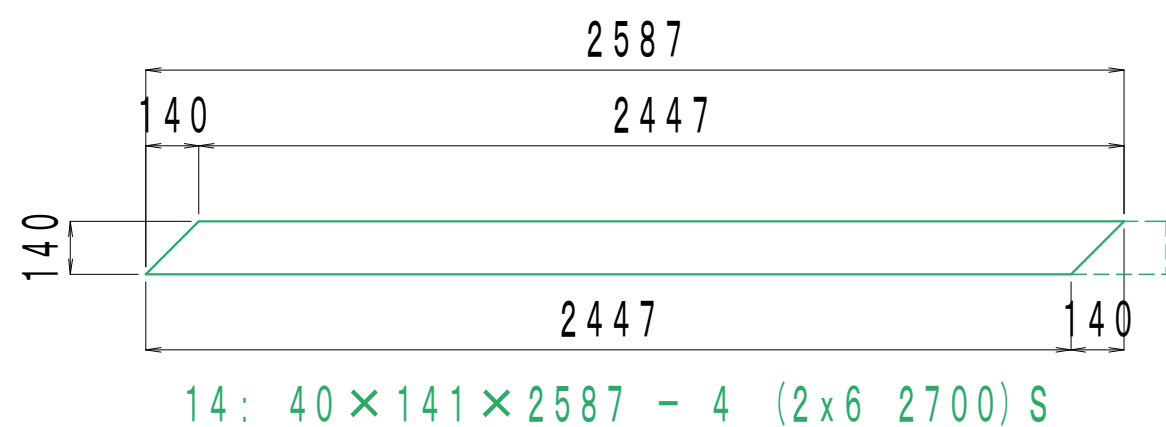
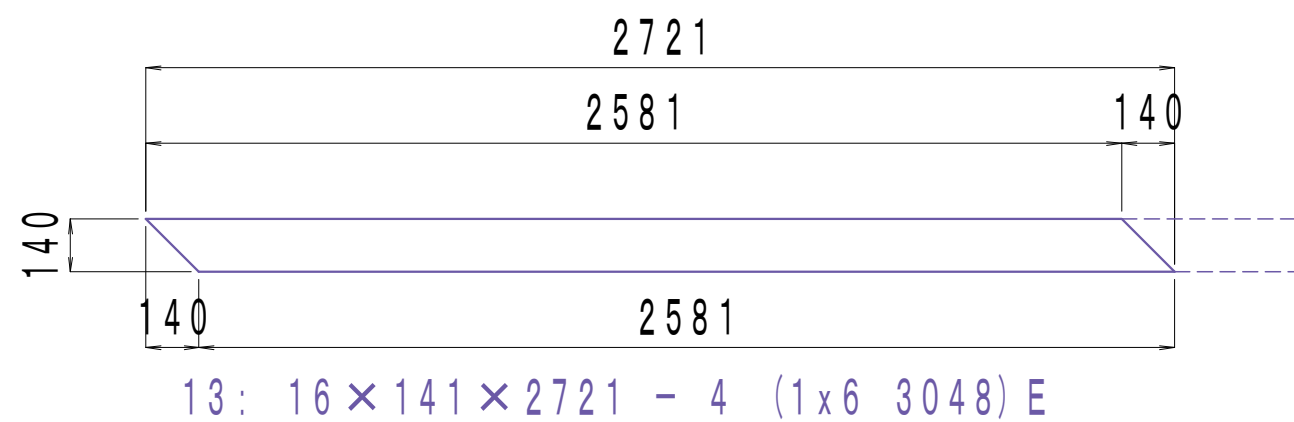
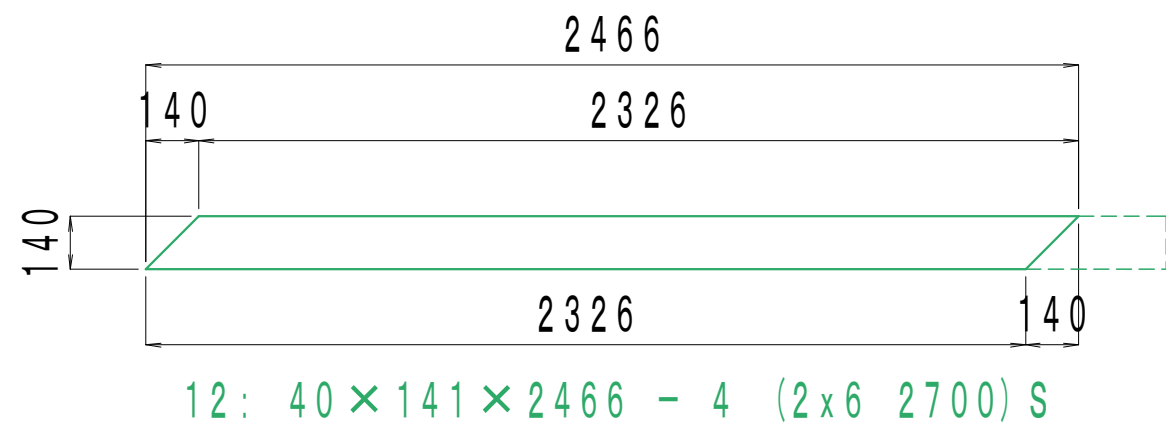

デッキ部加工図 (柵)

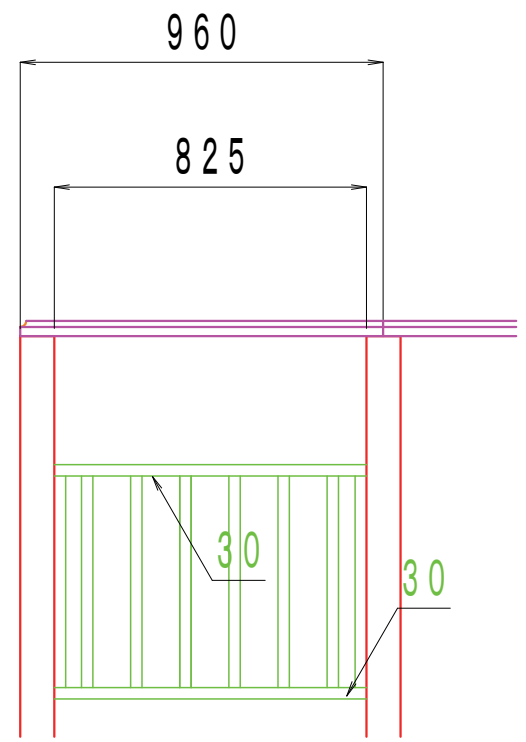
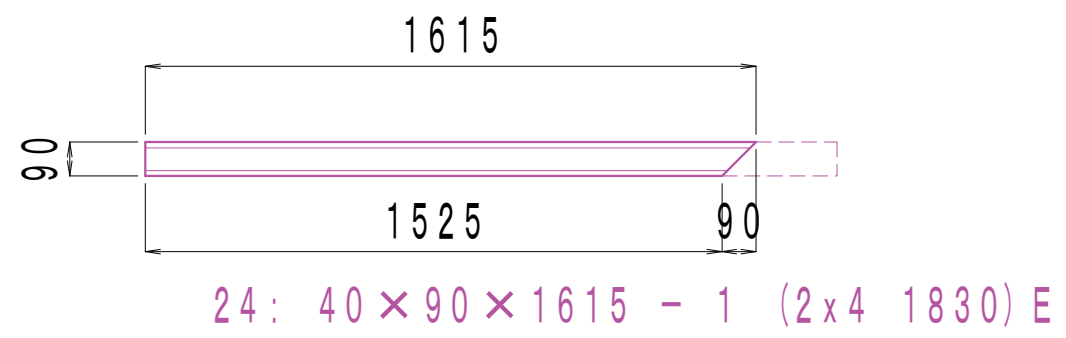
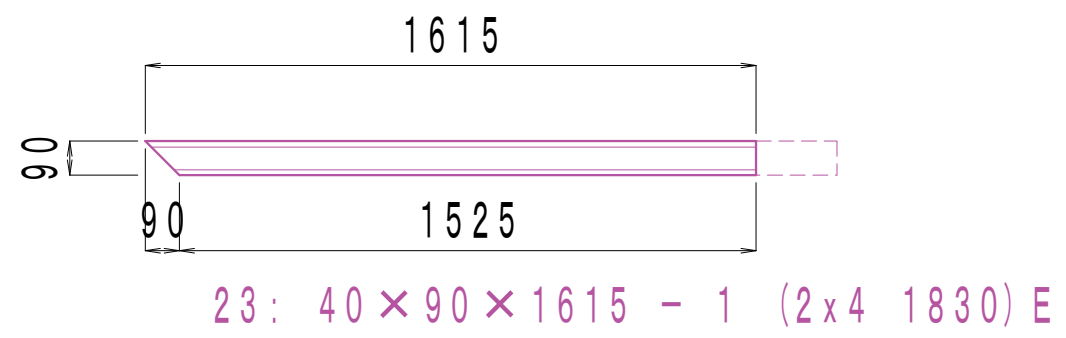
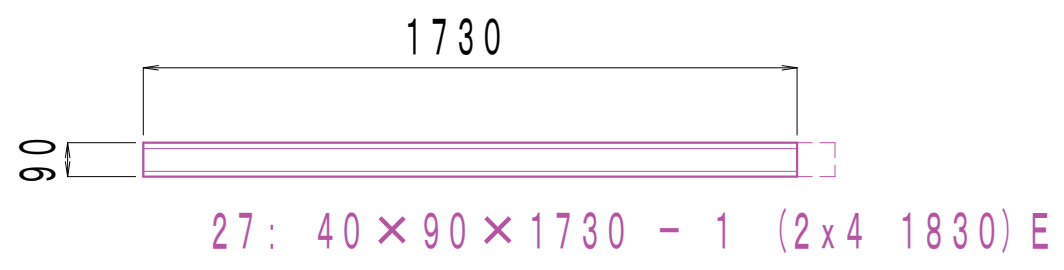
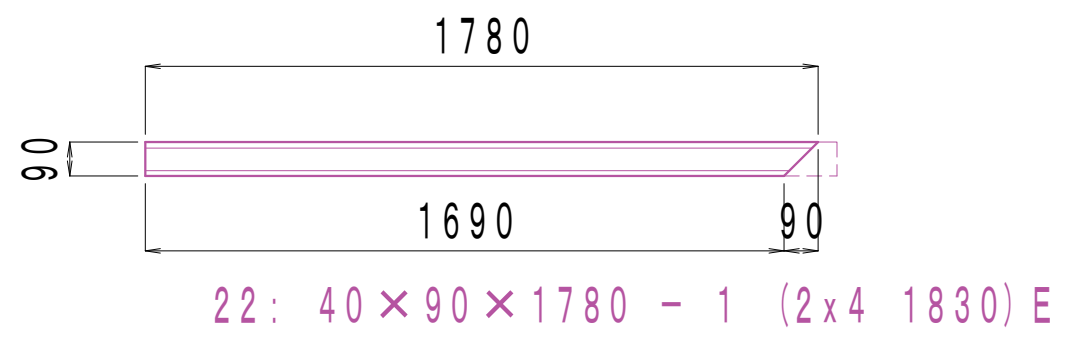
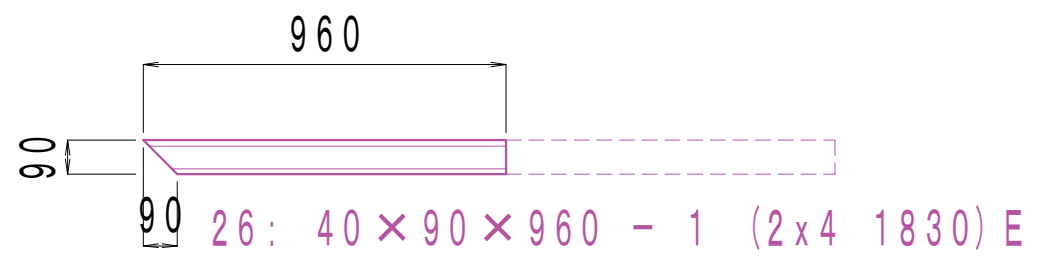
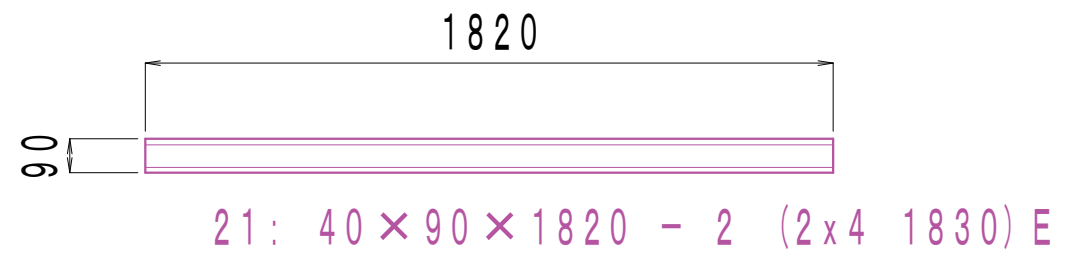
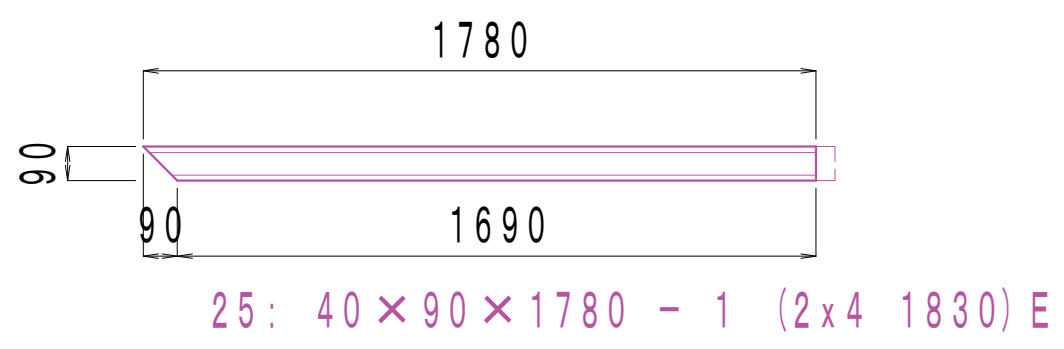
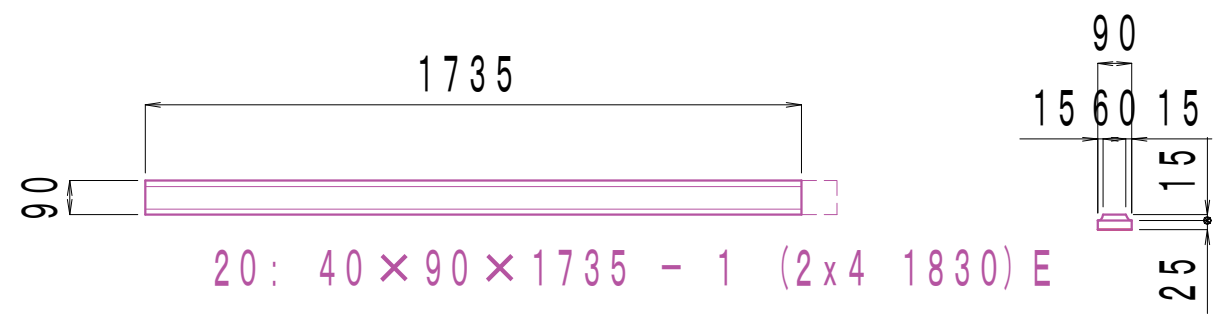

デッキ部加工図 (枠材・数量)

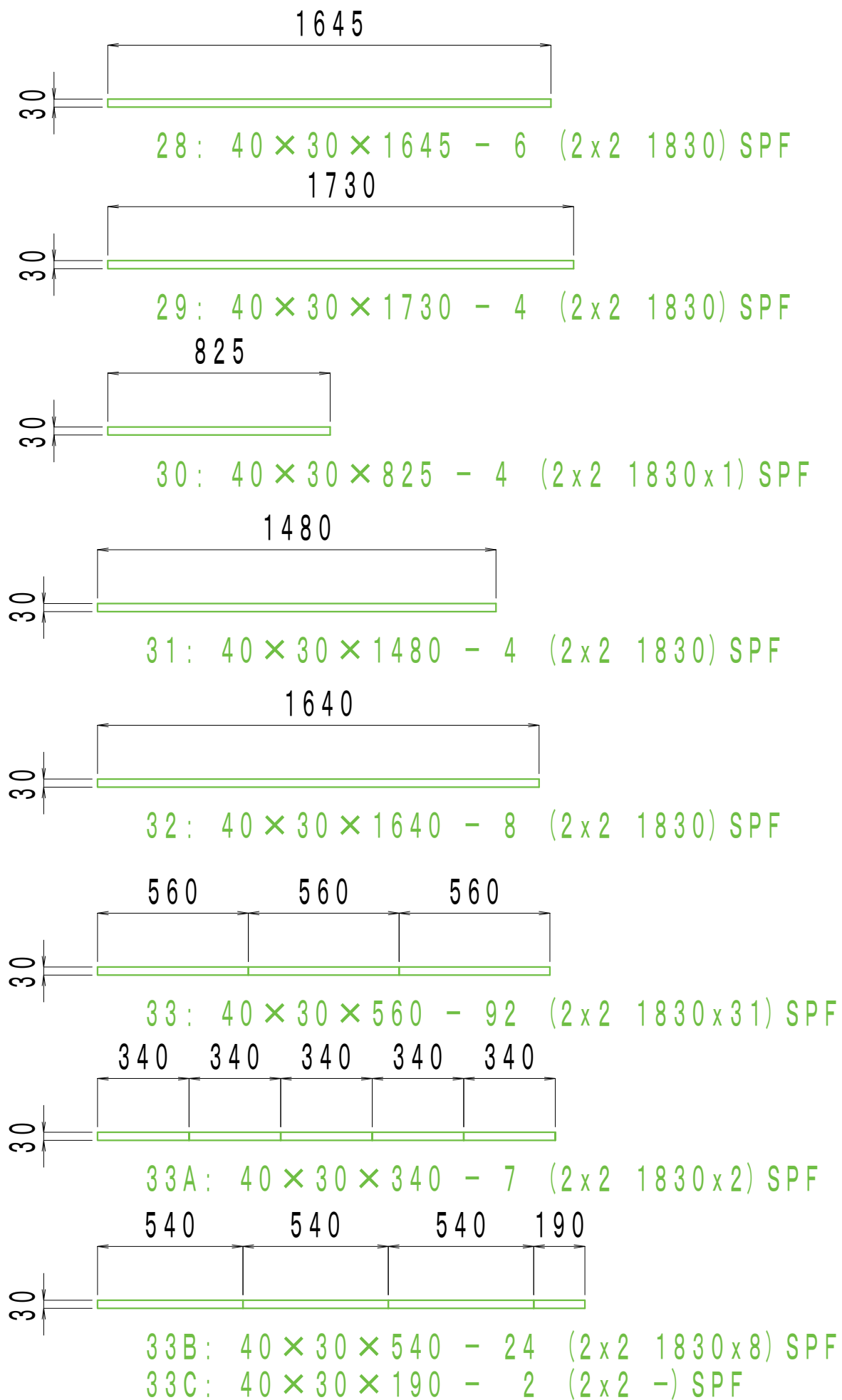

数量計算 (デッキ部)

番号	断面	長さ	単価	本数	金額
1	4 X 4	3,600	3,900	8	31,200
2	2 X 6	2,400	1,370	1	1,370
3	2 X 6	1,830	1,180	6	7,080
4	2 X 6	3,600	2,250	2	4,500
5	2 X 6	1,830	1,180	4	4,720
6	2 X 6	3,600	2,250	4	9,000
7	2 X 6	1,830	1,180	2	2,360
8	2 X 6	3,600	2,250	2	4,500
9	2 X 4	3,048	1,430	4	5,720
10	2 X 6	1,830	1,180	6	7,080
11	2 X 6	3,600	2,250	1	2,250
12	2 X 6	2,700	1,570	4	6,280
13	1 X 6	3,048	1,750	4	7,000
14	2 X 6	2,700	1,570	4	6,280
15	1 X 6	2,440	1,500	2	3,000
16	4 X 4	3,600	3,900	1	3,900
17	2 X 6	1,830	1,180	63	74,340
18	2 X 6	1,830	1,180	4	4,720
19	2 X 6	1,830	1,180	2	2,360
20	2 X 4	1,830	750	1	750
21	2 X 4	1,830	750	2	1,500
22	2 X 4	1,830	750	1	750
23	2 X 4	1,830	750	1	750
24	2 X 4	1,830	750	1	750
25	2 X 4	1,830	750	1	750
26	2 X 4	1,830	750	1	750
27	2 X 4	1,830	750	1	750
小計					194,410
28	KD30 X 40	1,820	158	6	948
29	KD30 X 40	1,820	158	4	632
30	KD30 X 40	1,820	158	1	158
31	KD30 X 40	1,820	158	8	1,264
32	KD30 X 40	1,820	158	4	632
33	KD30 X 40	1,820	158	41	6,478
小計					10,112
合計					204,522

価格表 (木エランド-通販 WRC)				集計		
断面	長さ	単価	グレード	本数	金額	摘要
4 X 4	3,600	3,900	スタンダード	14	54,600	
2 X 10	1,830	2,650	エリート	4	10,600	
2 X 10	3,650	5,350	エリート	2	10,700	
2 X 6	1,200	850	エリート	1	850	
2 X 6	1,830	1,180	エリート	87	102,660	
2 X 6	2,400	1,370	スタンダード	1	1,370	
2 X 6	2,700	1,570	スタンダード	8	12,560	
2 X 6	3,600	2,250	スタンダード	9	20,250	
2 X 4	1,830	750	エリート	9	6,750	
2 X 4	3,048	1,430	エリート	4	5,720	
2 X 2	1,800	620	エリート	8	4,960	
1 X 6	2,440	1,500	エリート	2	3,000	
1 X 6	3,048	1,750	エリート	4	7,000	
木エランド購入分					241,020	
価格表 (ホームセンター系 SPF)						
KD30 X 40	1,820	158	カインズ 防腐無	100	16,116	
2 X 10	1,820	1,580	ホームック 防腐無	0	0	
2 X 10	3,660	3,180	ホームック 防腐無	0	0	
2 X 6	1,820	898	ホームック 防腐無	0	0	
2 X 4	1,820	298	ホームック 防腐無	0	0	
2 X 4	1,820	498	ジョイフル 防腐有	78	38,844	
1 X 4	1,820	148	カインズ 防腐無	3	444	
1 X 2	1,820	368	ホームック 防腐無	1	368	
ホームセンター購入分					55,772	
木材合計					296,792	

総工費				
項目	規格	単価	本数	金額
羽子板付束石	150x150x300	1,280	8	10,240
束石	150x150x300	1,180	2	2,360
ツ-ハ`イ用束石	200x200x305	780	4	3,120
基礎パッキン	100x100x20	128	8	1,024
ホ`リカーホ`ネ-ト板	910x1820x4	1,980	9	17,820
塗料	カ`-ト`ラックラテックス			10,500
コースレット`	SUS410ステンレス		8	7,200
小計				52,264
木材合計				296,792
金具等	5%			14,840
総計				363,896

廊下・階段部平面図

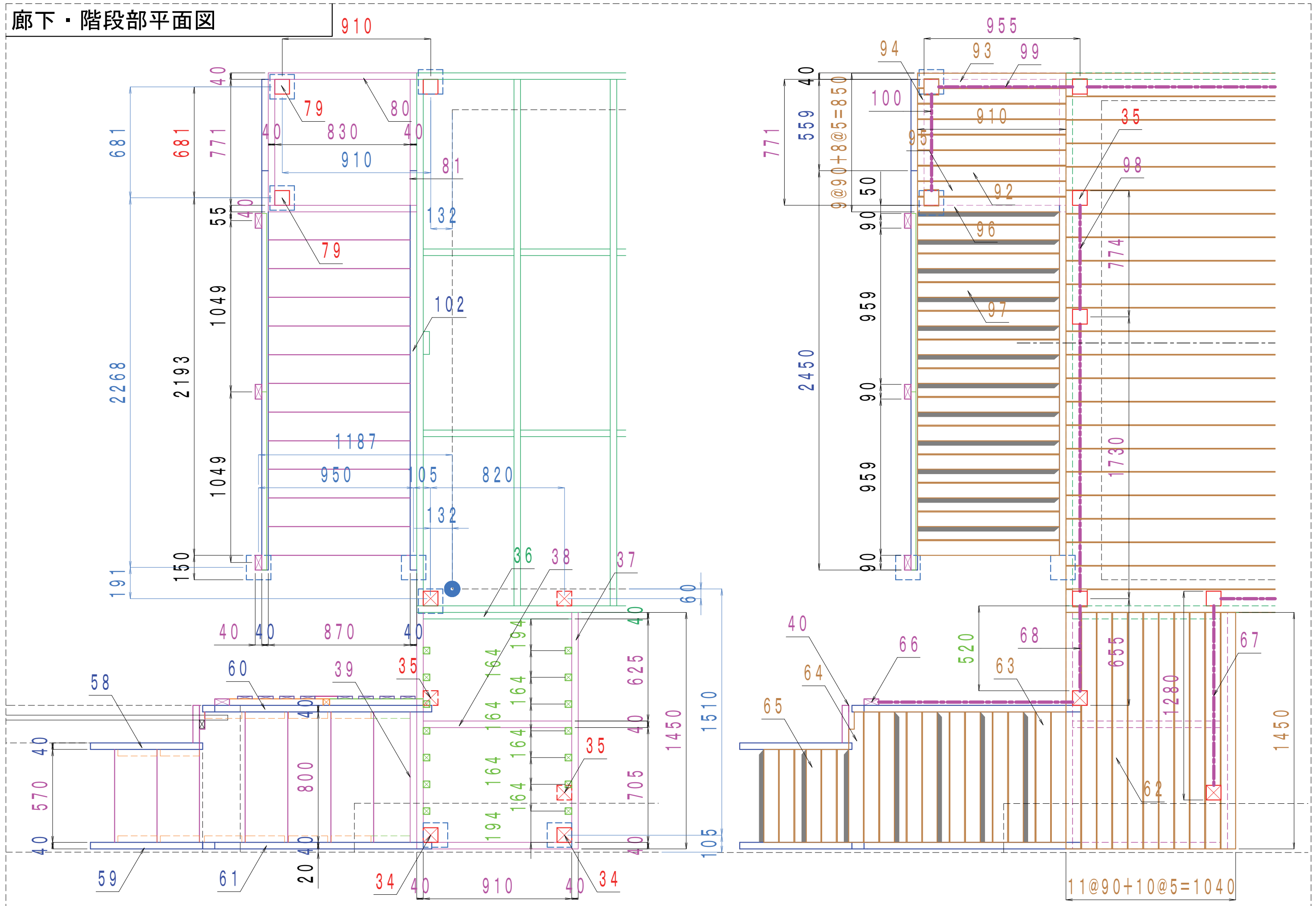

廊下部側面図・正面図

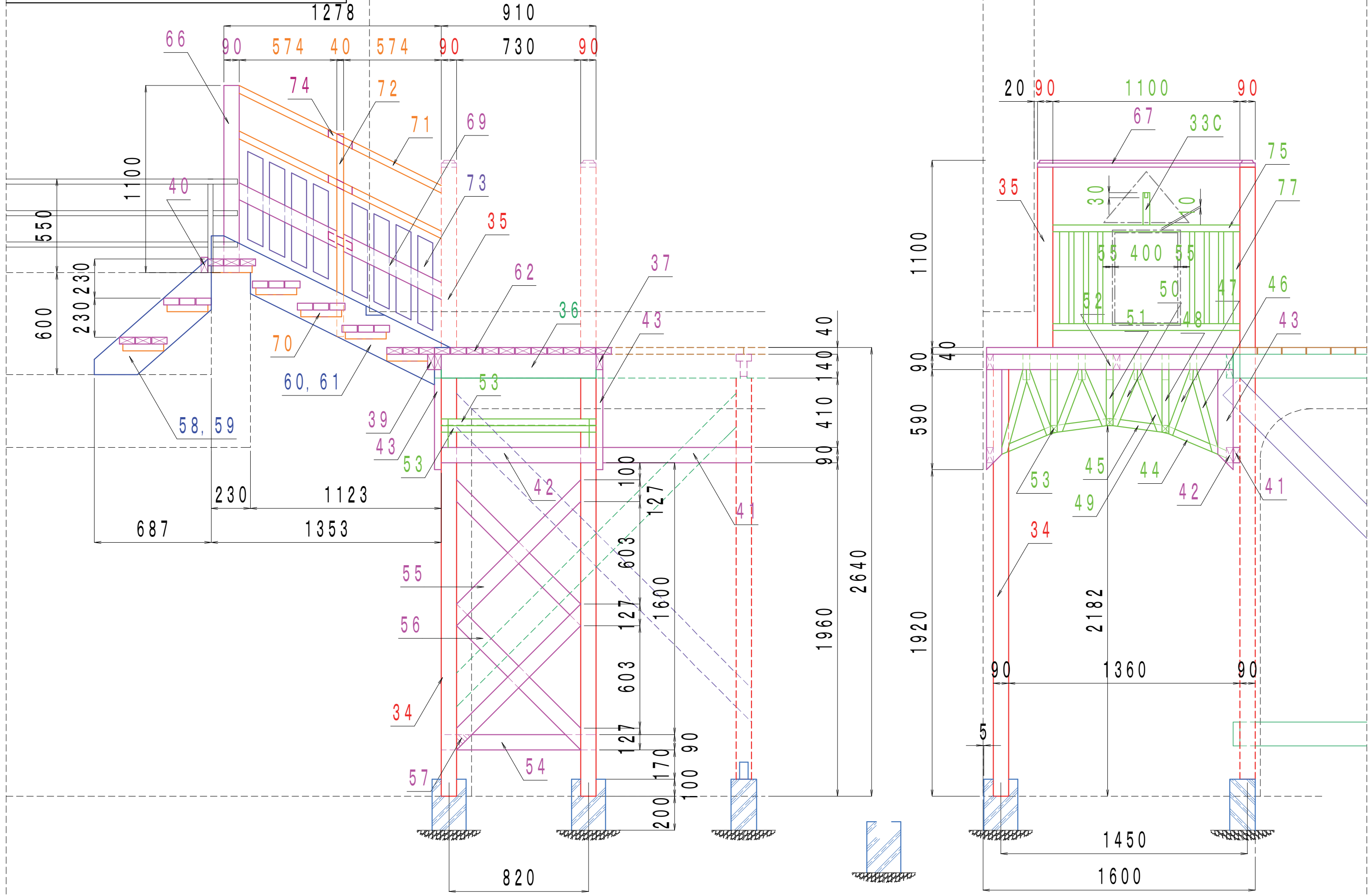

階段部正面図側面図

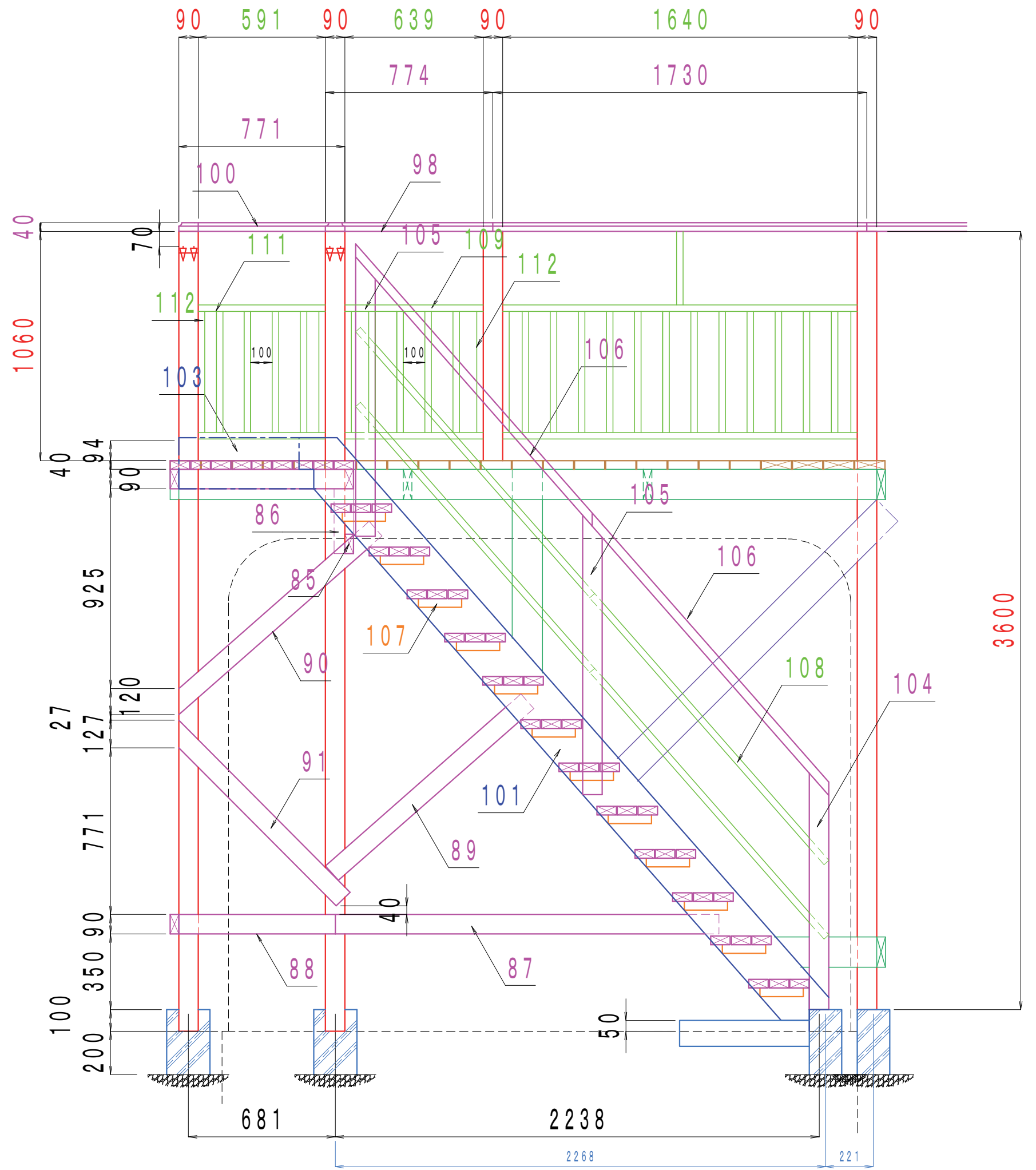
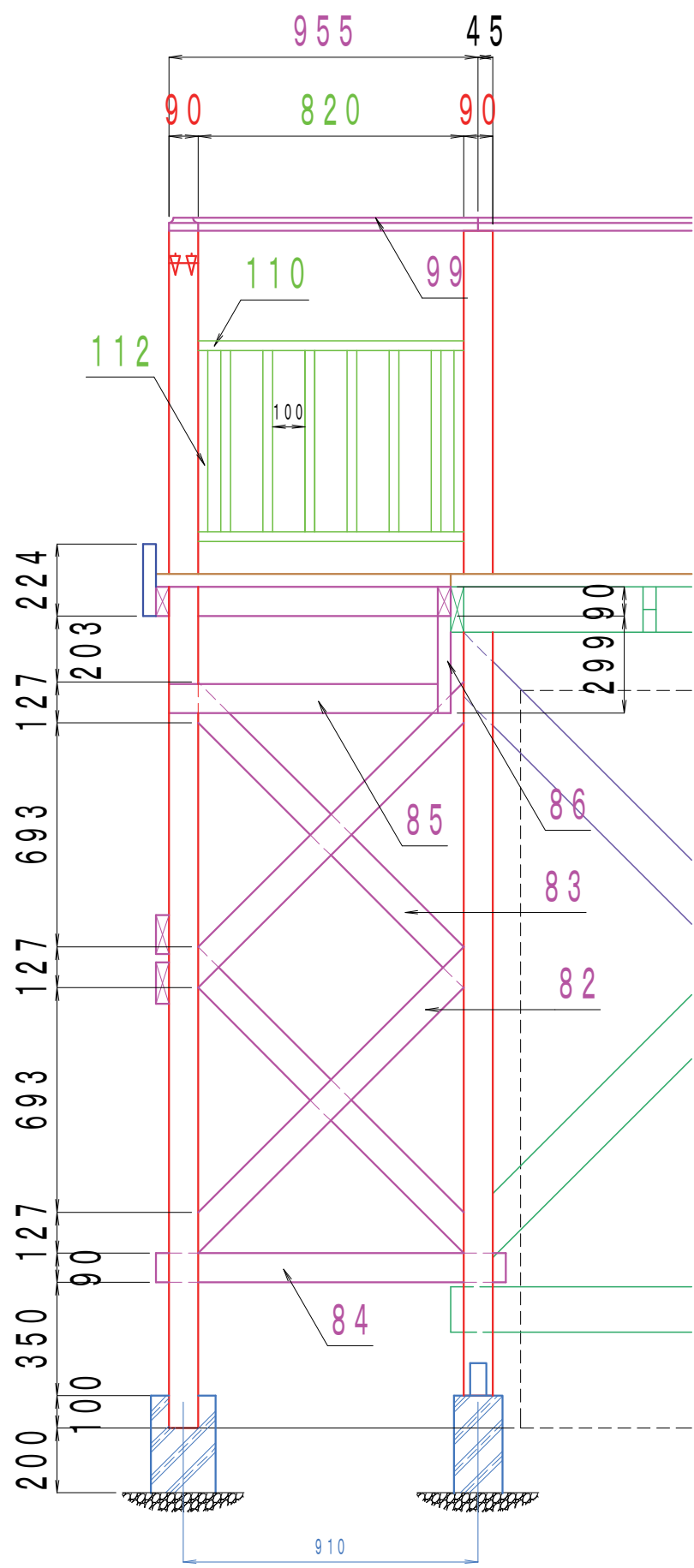

廊下部加工図 (柱・根太・筋交)

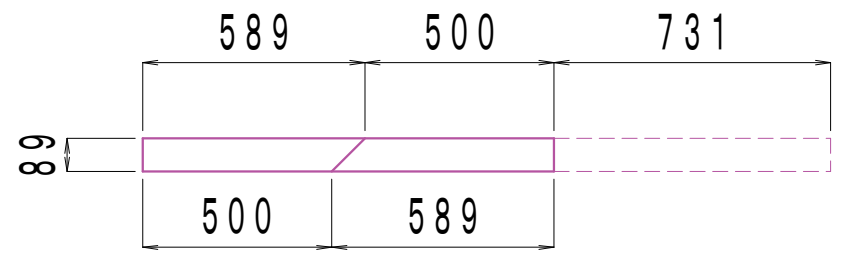
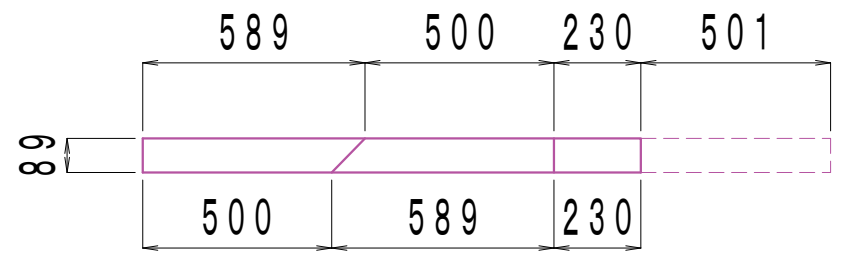
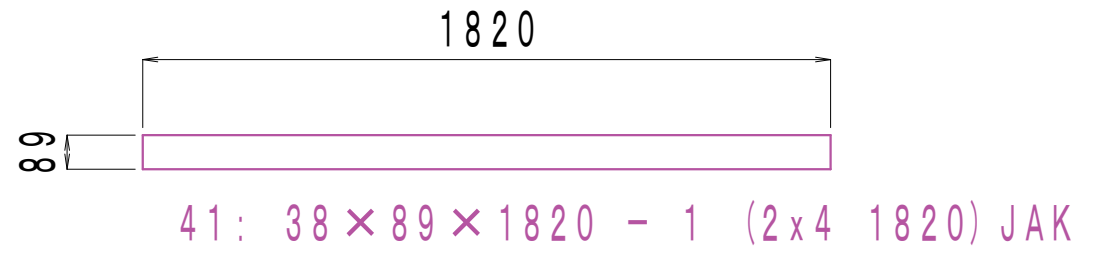
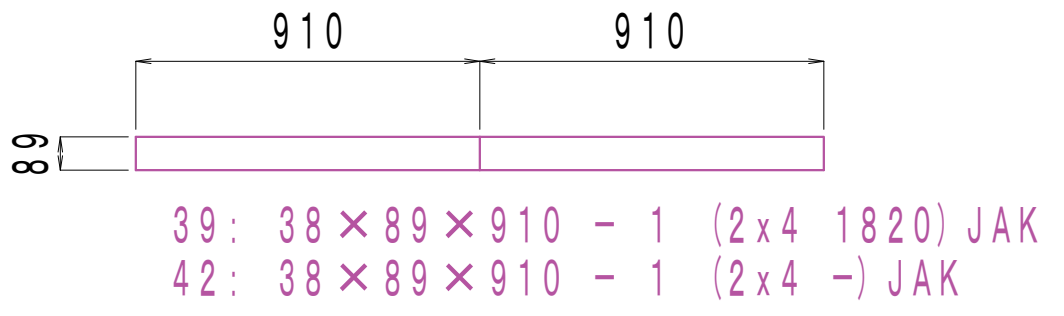
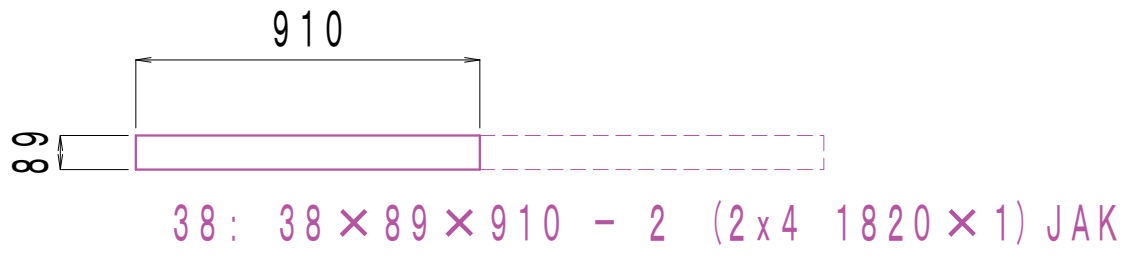
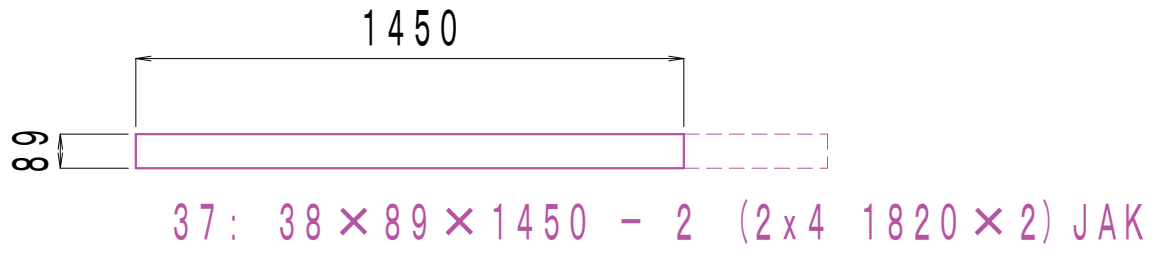
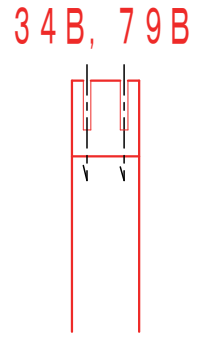
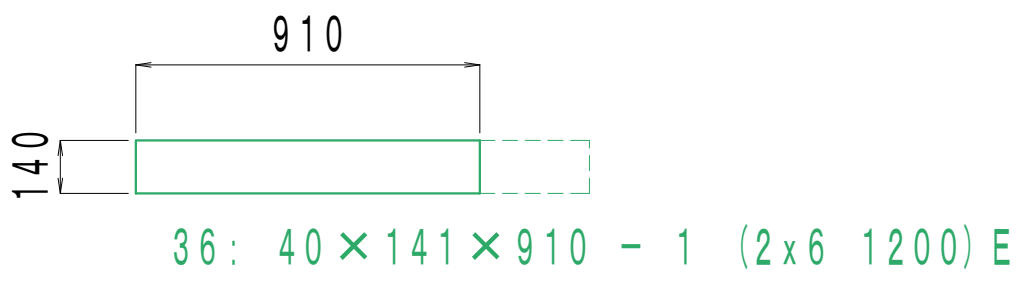
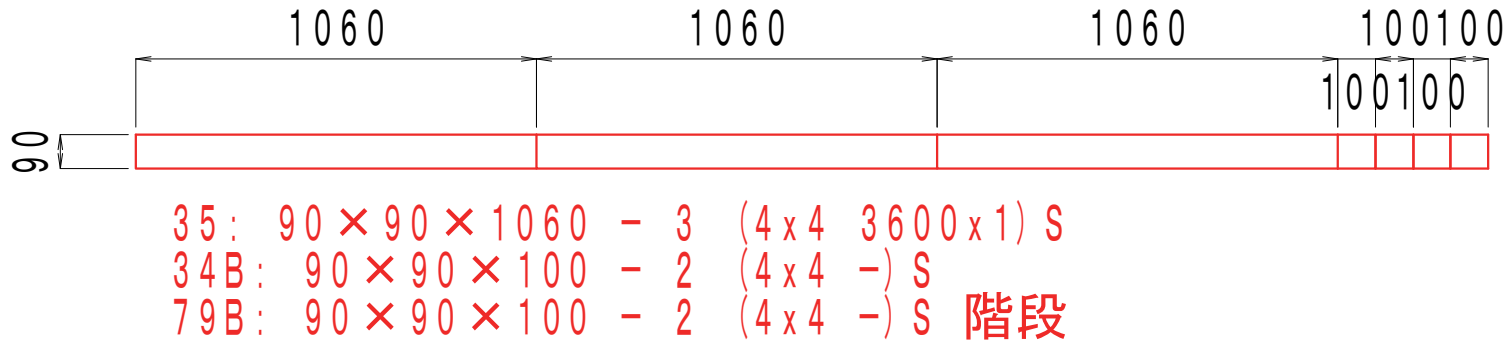
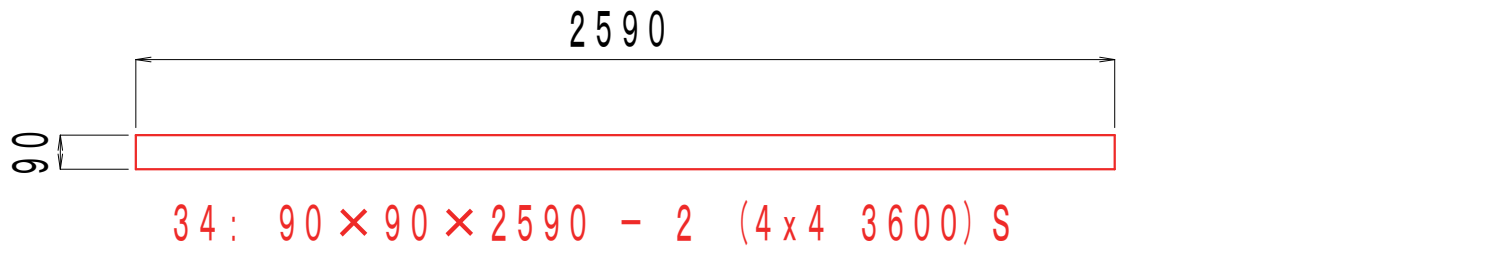

40: $38 \times 89 \times 230 - 1 (2 \times 4 \ 1820 \times 2) JAK$
 43: $38 \times 89 \times 589 - 4 (2 \times 4 \ -) JAK$

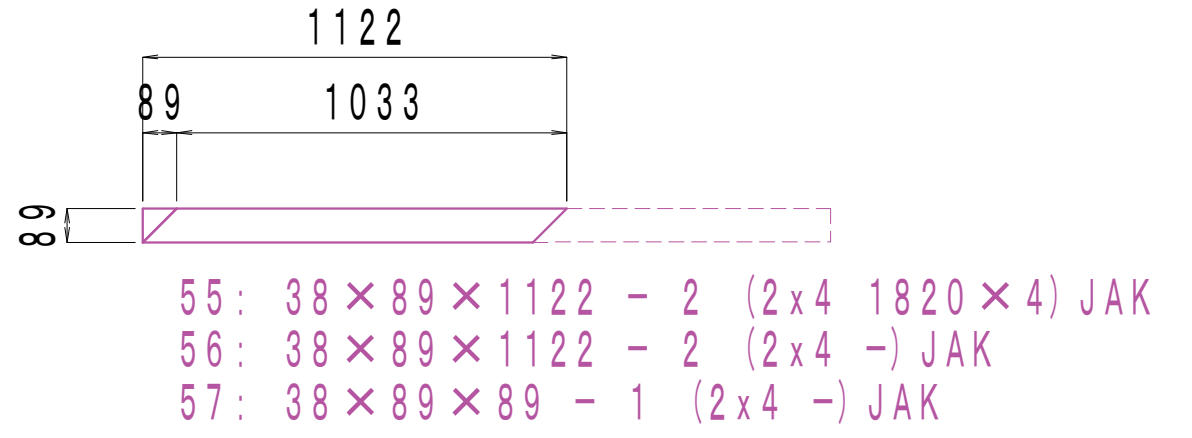
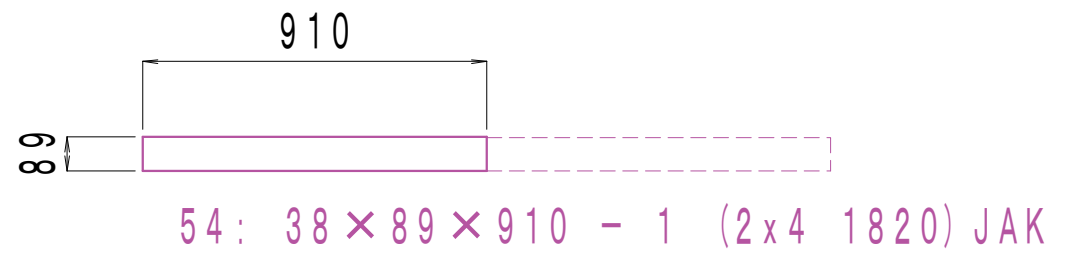

廊下部加工図 (トラス・階段)

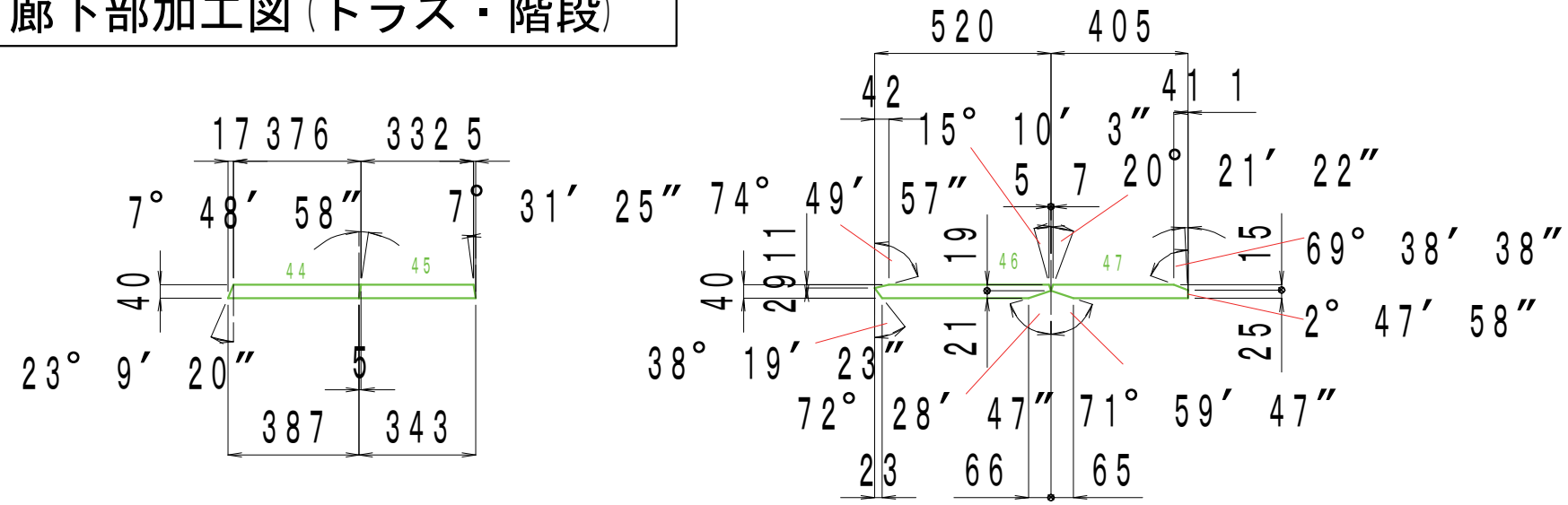

- 44: 40 × 30 × 387 - 4 (2x2 1800 × 4) SPF
- 45: 40 × 30 × 343 - 4 (2x2 -) SPF
- 46: 40 × 30 × 520 - 4 (2x2 -) SPF
- 47: 40 × 30 × 405 - 4 (2x2 -) SPF

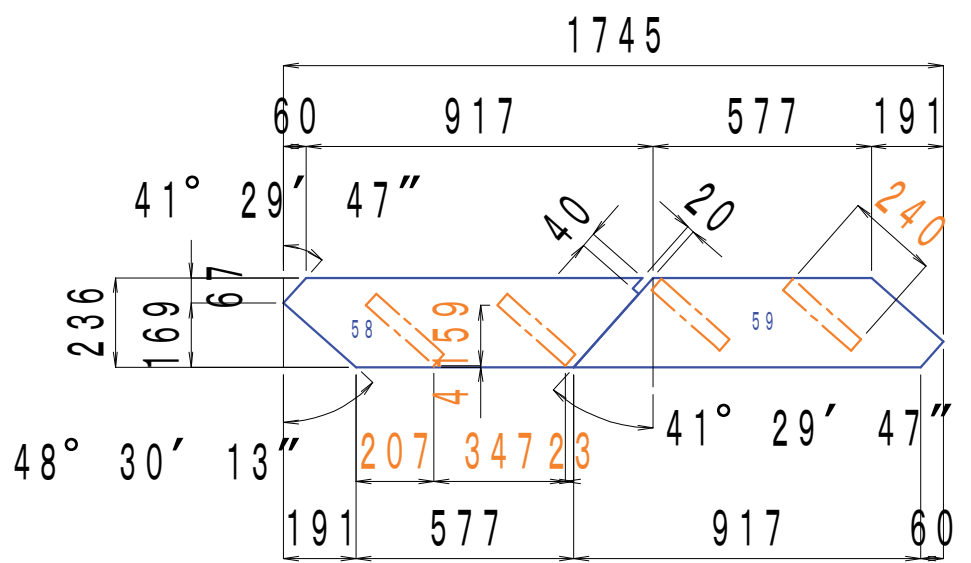

- 58: 40 × 236 × 977 - 1 (2x10 1830 × 1) E
- 59: 40 × 236 × 977 - 1 (2x10 -) E

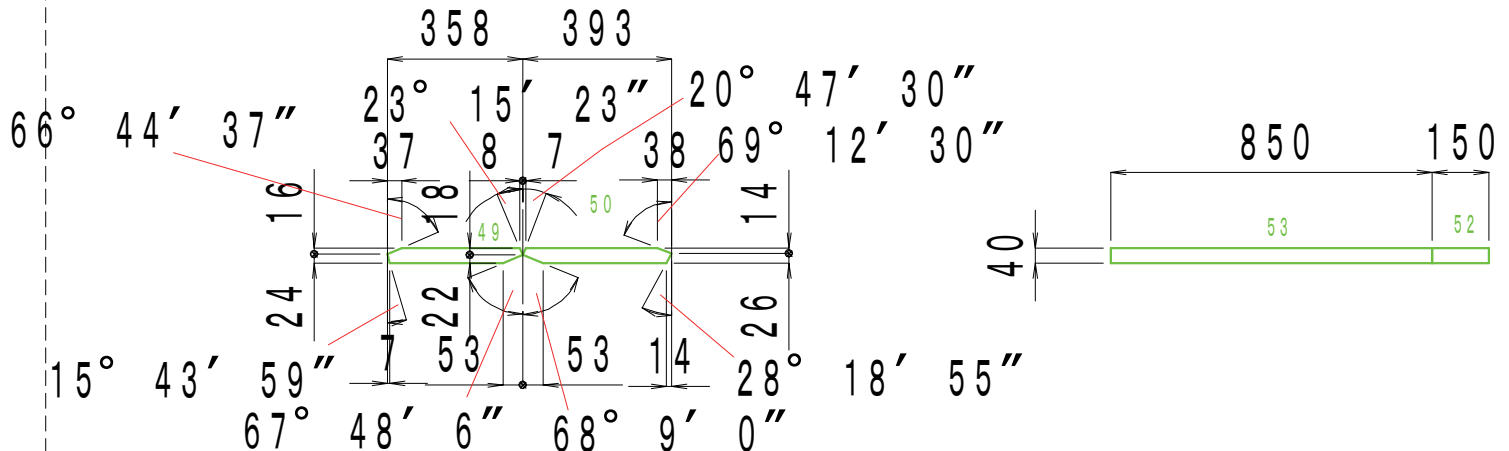

- 49: 40 × 30 × 358 - 4 (2x2 1800 × 4) SPF
- 50: 40 × 30 × 393 - 4 (2x2 -) SPF
- 53: 40 × 30 × 850 - 3 (2x2 -) SPF
- 52: 40 × 30 × 150 - 4 (2x2 -) SPF

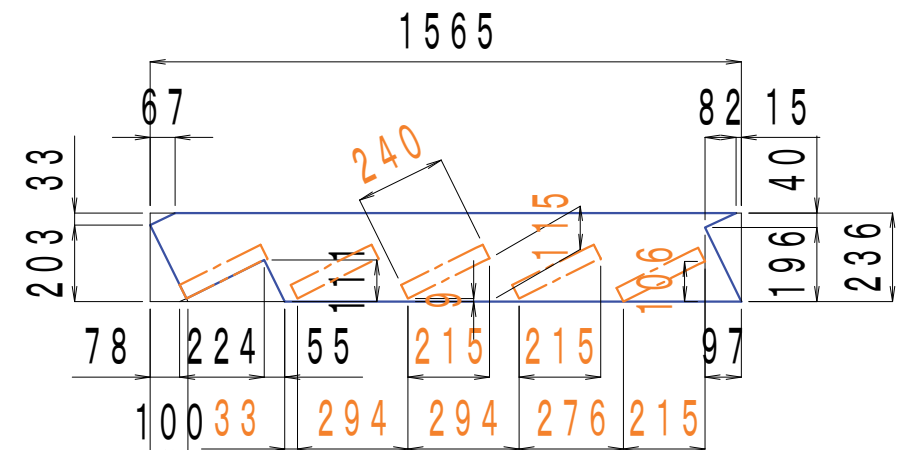

- 60: 40 × 236 × 1565 - 1 (2x10 1830) E

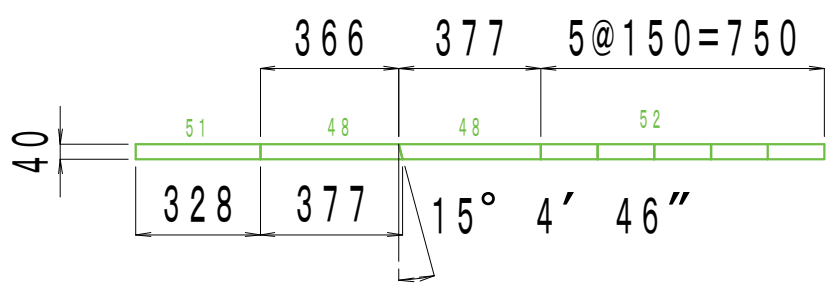

- 48: 40 × 30 × 377 - 4 (2x2 1800 × 2) SPF
- 51: 40 × 30 × 328 - 2 (2x2 -) SPF
- 52: 40 × 30 × 150 - 10 (2x2 -) SPF

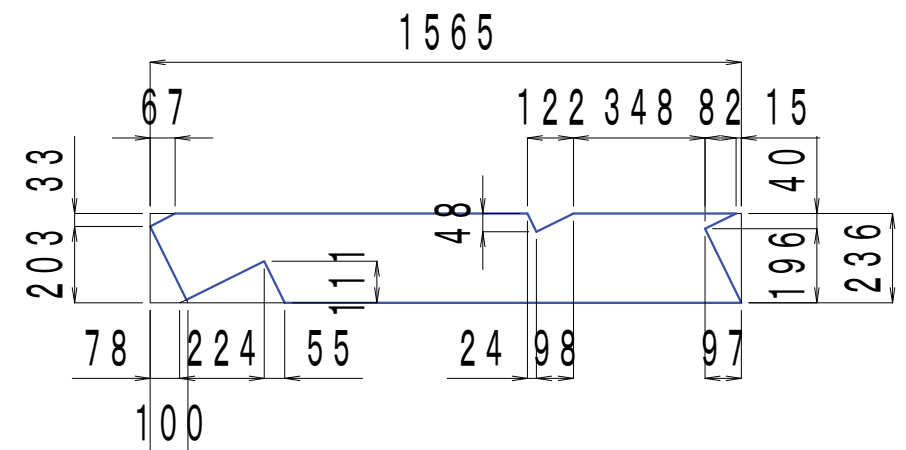

- 61: 40 × 236 × 1565 - 1 (2x10 1830) E

廊下部加工図 (床材・柵・階段)

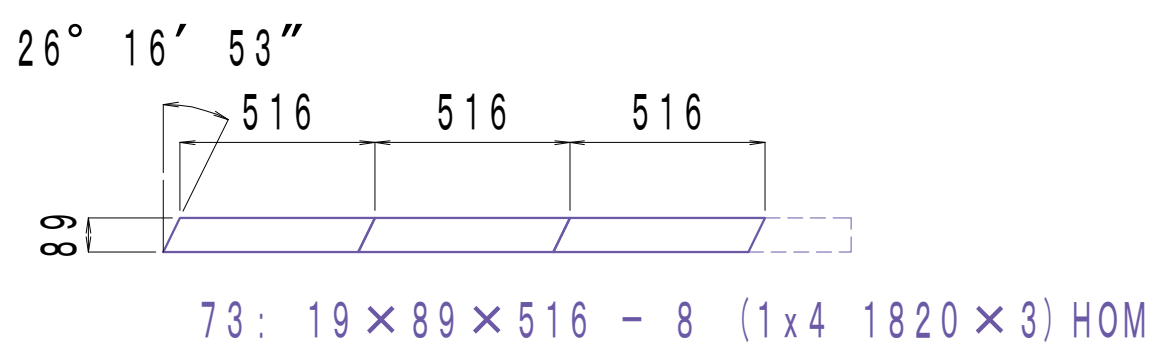
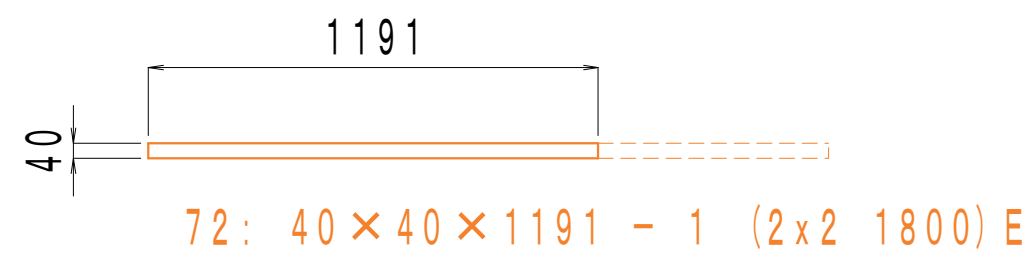
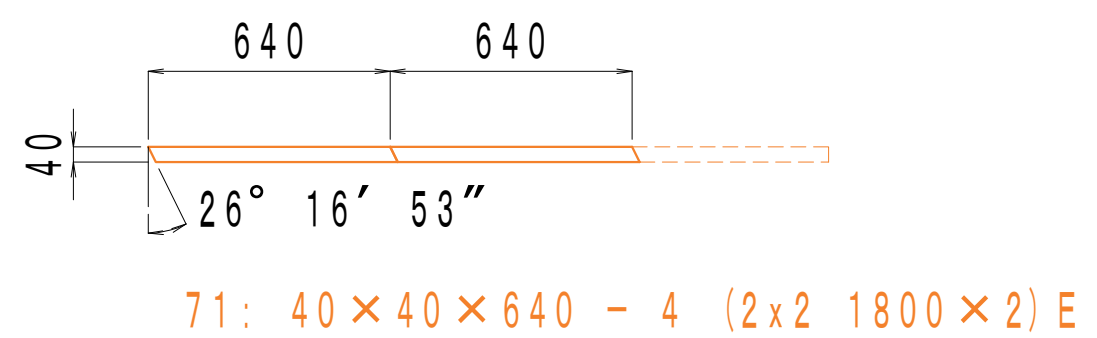
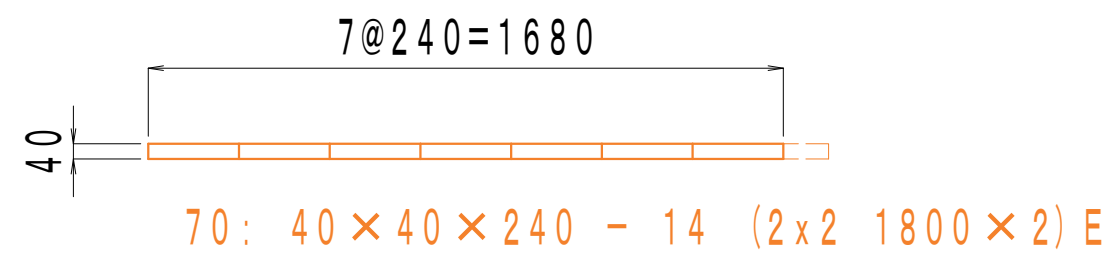
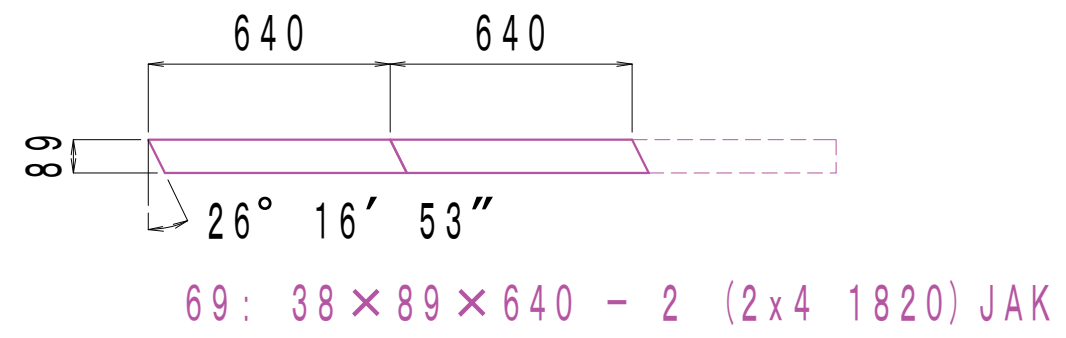
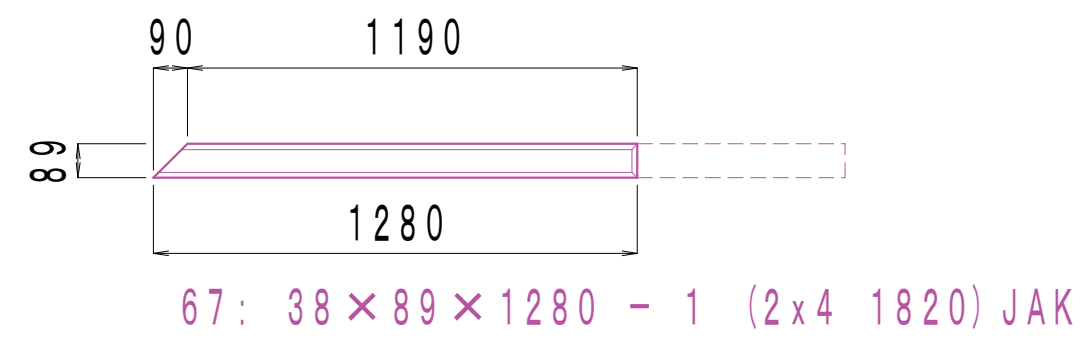
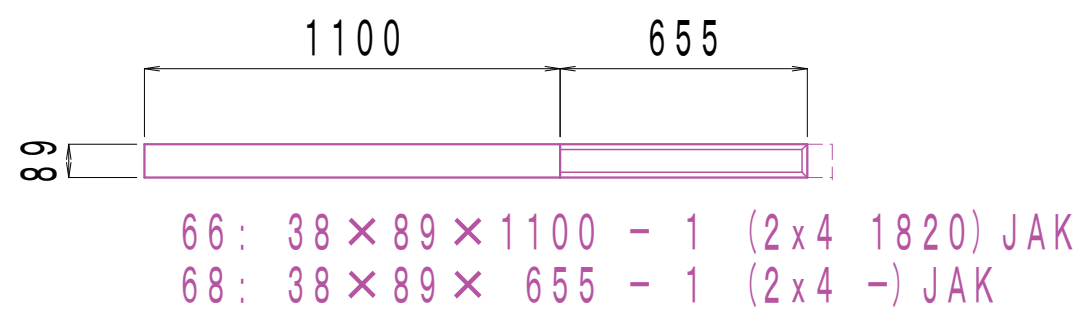
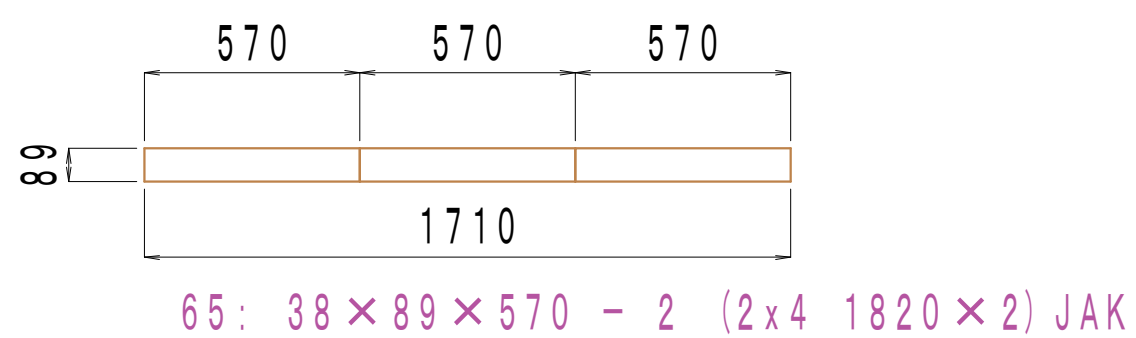
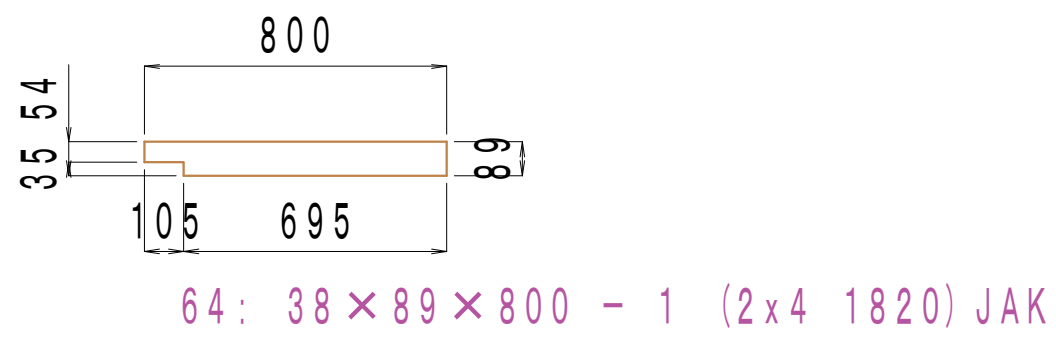
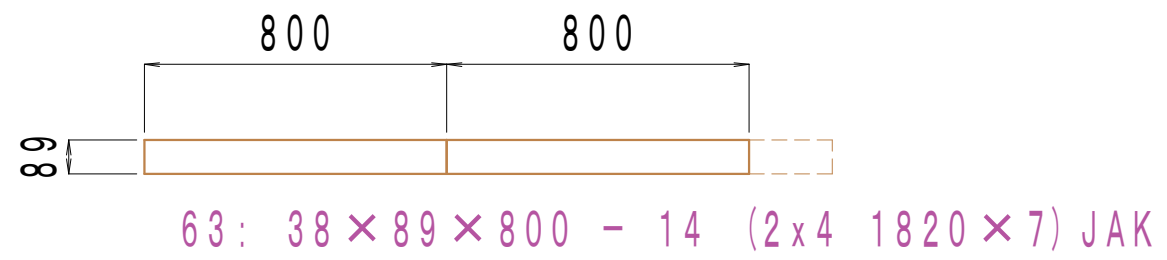
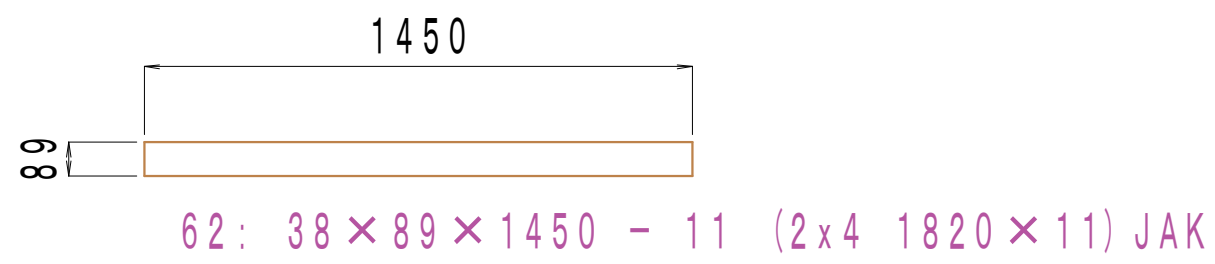

廊下部加工図 (柵・枠材・数量)

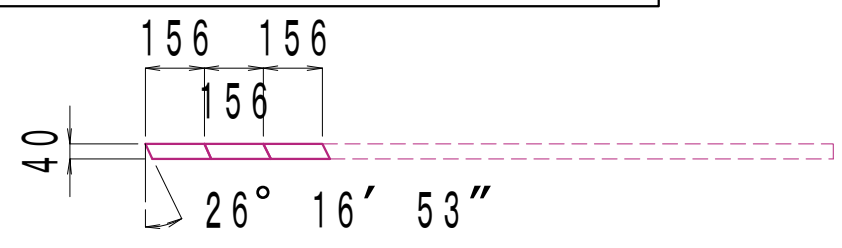

74: 19×38×156 - 3 (1x2 1820) HOM

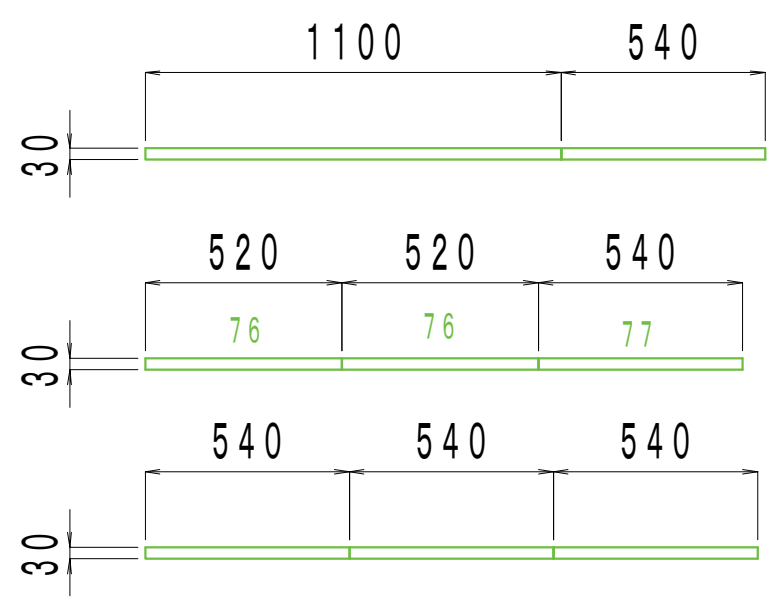

75: 40×30×1100 - 4 (2x2 1830×9) SPF
 76: 40×30×520 - 2 (2x2 -) SPF
 77: 40×30×540 - 10 (2x2 -) SPF
 78: 40×30×540 - 5 (2x2 -) SPF

数量計算 (廊下部)

番号	断面	長さ	単価	本数	金額
34	4X4	3,600	3,900	2	7,800
35	4X4	3,600	3,900	1	3,900
36	2X6	1,200	850	1	850
37	2X4	1,820	498	2	996
38	2X4	1,820	498	1	498
39	2X4	1,820	498	1	498
40	2X4	1,820	498	2	996
41	2X4	1,820	498	1	498
42	2X4	1,820	498	0	0
43	2X4	1,820	498	0	0
44	KD30×40	1,820	158	4	632
45	KD30×40	1,820	158	0	0
46	KD30×40	1,820	158	0	0
47	KD30×40	1,820	158	0	0
48	KD30×40	1,820	158	2	316
49	KD30×40	1,820	158	4	632
50	KD30×40	1,820	158	0	0
51	KD30×40	1,820	158	0	0
52	KD30×40	1,820	158	0	0
53	KD30×40	1,820	158	0	0
54	2X4	1,820	498	1	498
55	2X4	1,820	498	4	1,992
56	2X4	1,820	498	0	0
57	2X4	1,820	498	0	0
58	2X10	1,830	2,650	1	2,650
59	2X10	1,830	2,650	0	0
60	2X10	1,830	2,650	1	2,650
61	2X10	1,830	2,650	1	2,650
62	2X4	1,820	498	11	5,478
63	2X4	1,820	498	7	3,486
64	2X4	1,820	498	1	498
65	2X4	1,820	498	2	996
66	2X4	1,820	498	1	498
67	2X4	1,820	498	1	498
68	2X4	1,820	498	0	0
69	2X4	1,820	498	1	498
70	2x2	1,800	620	2	1,240
71	2x2	1,800	620	2	1,240
72	2x2	1,800	620	1	620
73	1X4	1,820	148	3	444
74	1X2	1,820	368	1	368
75	KD30×40	1,820	158	9	1,422
76	KD30×40	1,820	158	0	0
77	KD30×40	1,820	158	0	0
78	KD30×40	1,820	158	0	0
小計					45,342
合計					249,548

数量計算 (階段部)

番号	断面	長さ	単価	本数	金額
79	4X4	3,600	3,900	2	7,800
80	2X4	1,820	498	1	498
81	2X4	1,820	498	1	498
82	2X4	1,820	498	2	996
83	2X4	1,820	498	2	996
84	2X4	1,820	498	1	498
85	2X4	1,820	498	1	498
86	2X4	1,820	498	0	0
87	2X4	1,820	498	1	498
88	2X4	1,820	498	0	0
89	2X4	1,820	498	1	498
90	2X4	1,820	498	1	498
91	2X4	1,820	498	1	498
92	2X4	1,820	498	3	1,494
93	2X4	1,820	498	1	498
94	2X4	1,820	498	0	0
95	2X4	1,820	498	1	498
96	2X4	1,820	498	0	0
97	2X4	1,820	498	18	8,964
98	2X4	1,820	498	1	498
99	2X4	1,820	498	1	498
100	2X4	1,820	498	0	0
101	2X10	3,650	5,350	1	5,350
102	2X10	3,650	5,350	1	5,350
103	2X10	1,830	2,650	1	2,650
104	2X4	1,820	498	1	498
105	2X4	1,820	498	2	996
106	2X4	1,820	498	2	996
107	2x2	1,800	620	3	1,860
108	KD30×40	1,820	158	4	632
109	KD30×40	1,820	158	2	316
110	KD30×40	1,820	158	0	0
111	KD30×40	1,820	158	1	158
112	KD30×40	1,820	158	7	1,106
小計					46,138
合計					295,686

階段部加工図 (柱・根太・筋交)

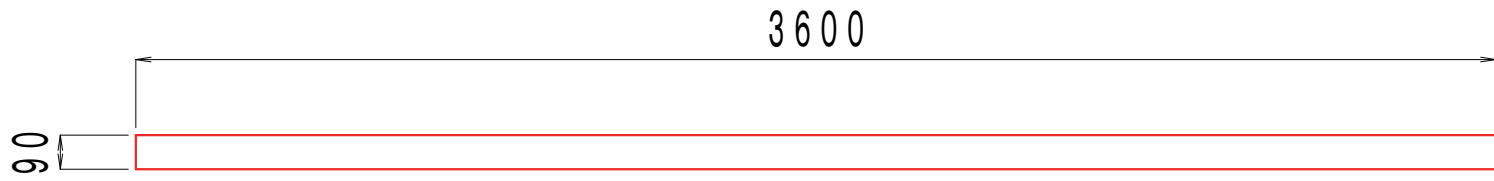

79: $90 \times 90 \times 3600 - 2 (4 \times 4 \ 3600) S$

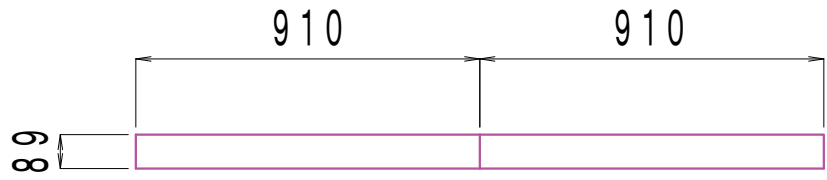

80: $38 \times 89 \times 910 - 2 (2 \times 4 \ 1820 \times 1) JAK$

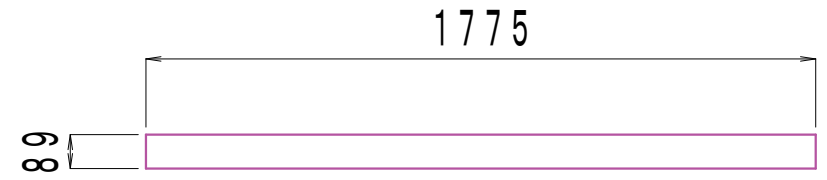

87: $38 \times 89 \times 1775 - 1 (2 \times 4 \ 1820 \times 1) JAK$

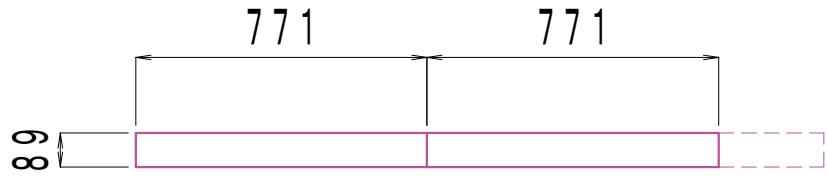

81: $38 \times 89 \times 771 - 2 (2 \times 4 \ 1820 \times 1) JAK$

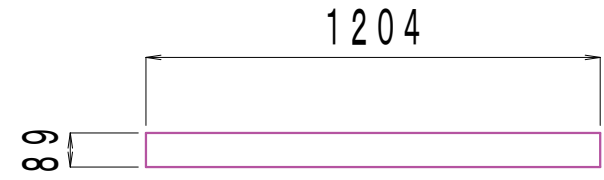

89: $38 \times 89 \times 1204 - 1 (2 \times 4 \ 1820 \times 1) JAK$

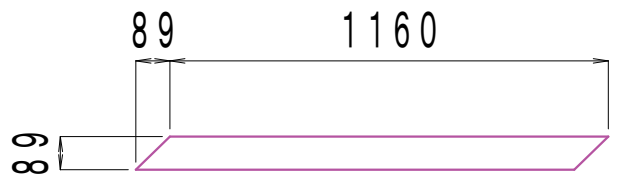

82: $38 \times 89 \times 1160 - 2 (2 \times 4 \ 1820 \times 2) JAK$

83: $38 \times 89 \times 1160 - 2 (2 \times 4 \ 1820 \times 2) JAK$

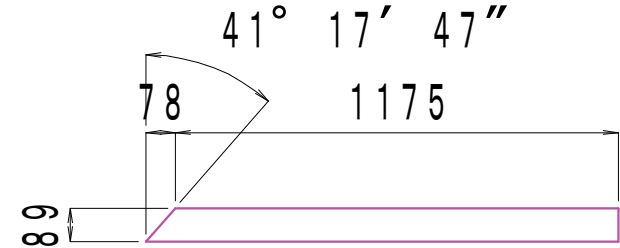

90: $38 \times 89 \times 1253 - 1 (2 \times 4 \ 1820 \times 1) JAK$

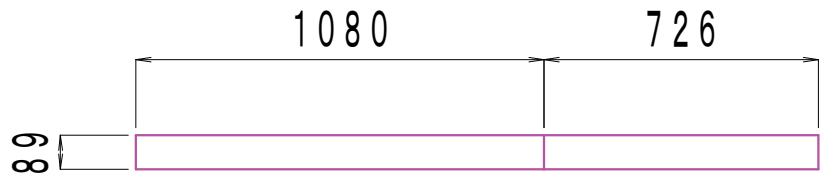

84: $38 \times 89 \times 1080 - 1 (2 \times 4 \ 1820 \times 1) JAK$

88: $38 \times 89 \times 726 - 1 (2 \times 4 \ -) JAK$

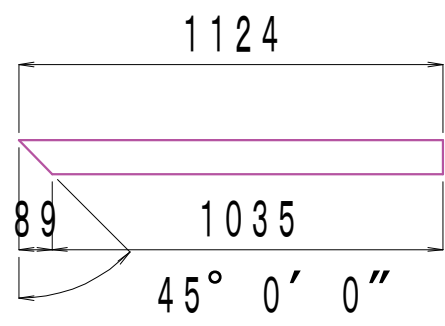

91: $38 \times 89 \times 1124 - 1 (2 \times 4 \ 1820 \times 1) JAK$

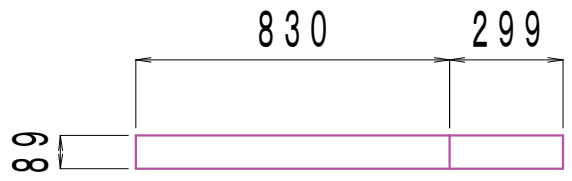

85: $38 \times 89 \times 830 - 1 (2 \times 4 \ 1820 \times 1) JAK$

86: $38 \times 89 \times 299 - 1 (2 \times 4 \ -) JAK$

階段部加工図 (床材・階段・柵)

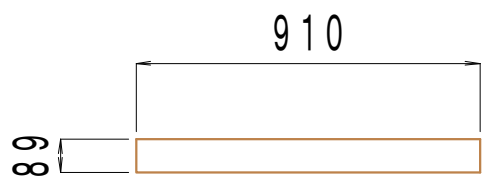

92: 38 × 89 × 910 - 5 (2x4 1820 × 3) JAK

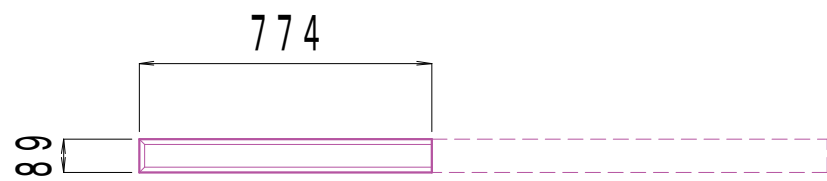

98: 38 × 89 × 774 - 1 (2x4 1820) JAK

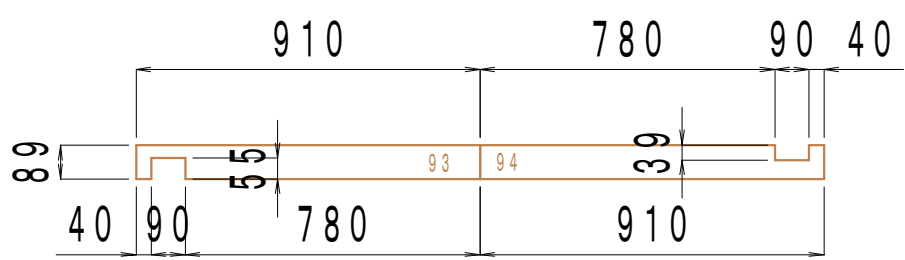

93: 38 × 89 × 910 - 1 (2x4 1820 × 1) JAK
94: 38 × 89 × 910 - 1 (2x4 -) JAK

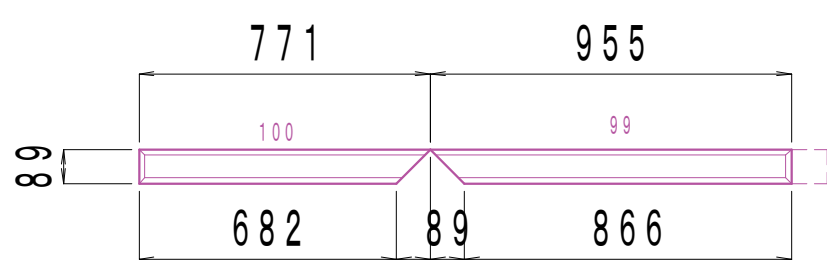

99: 38 × 89 × 955 - 1 (2x4 1820) JAK
100: 38 × 89 × 771 - 1 (2x4 -) JAK

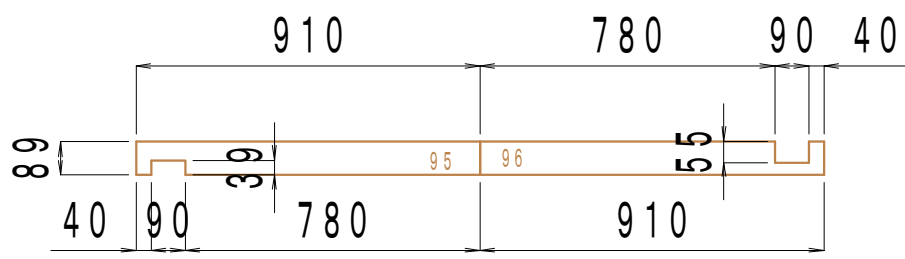

95: 38 × 89 × 910 - 1 (2x4 1820 × 1) JAK
96: 38 × 89 × 910 - 1 (2x4 -) JAK

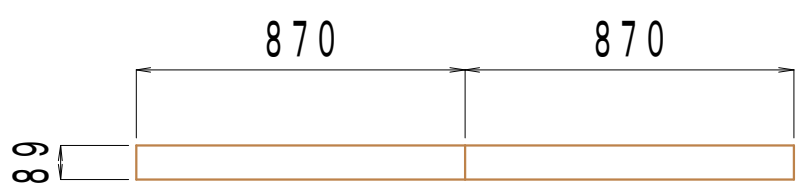

97: 38 × 89 × 870 - 36 (2x4 1820 × 18) JAK

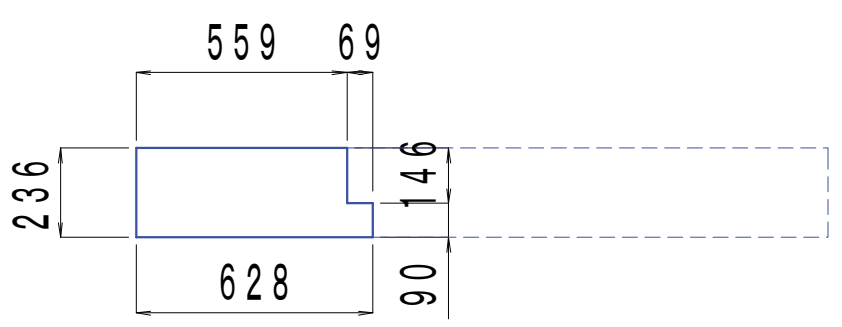

103: 40 × 236 × 628 - 1 (2x10 1830 × 1) E

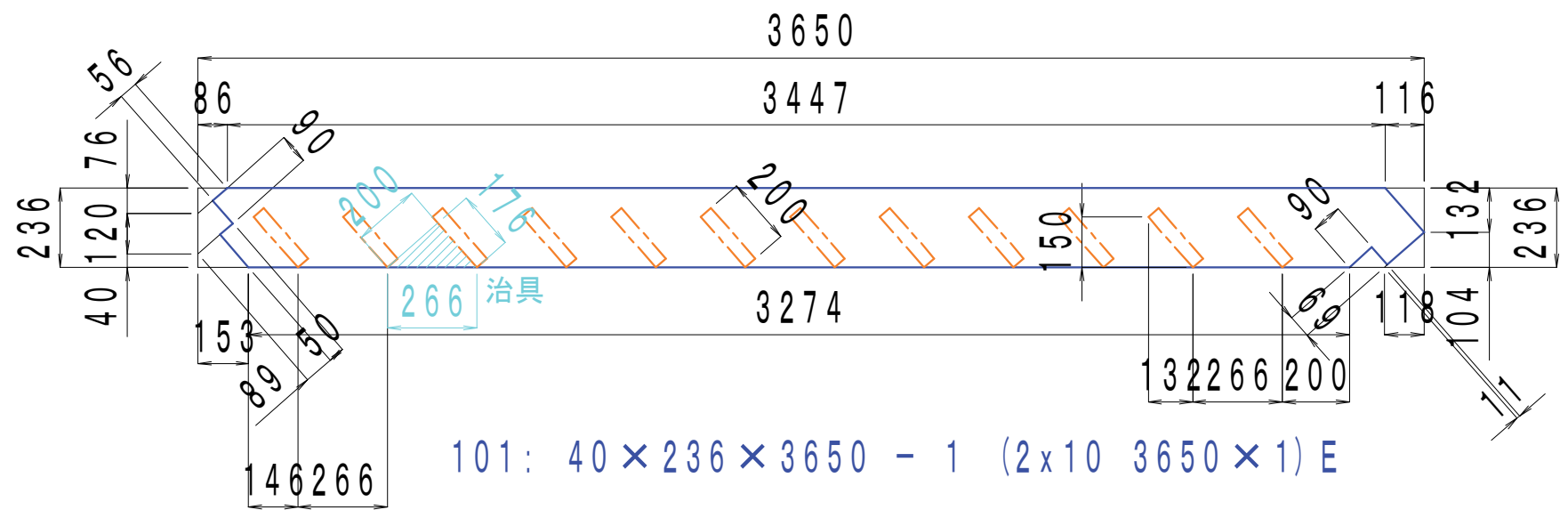

101: 40 × 236 × 3650 - 1 (2x10 3650 × 1) E

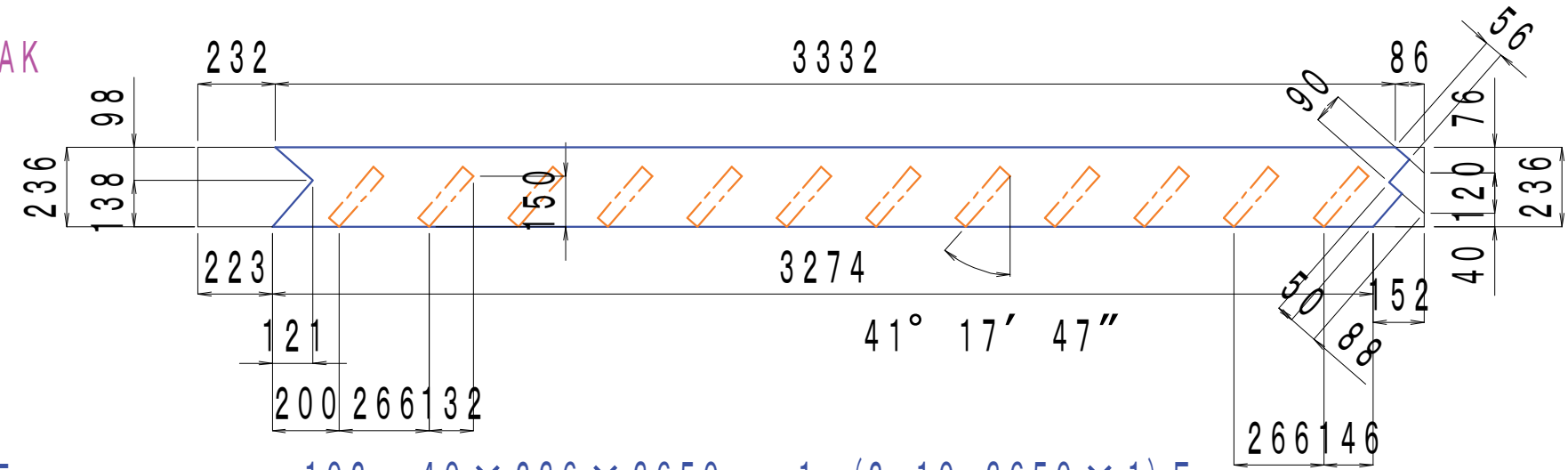

102: 40 × 236 × 3650 - 1 (2x10 3650 × 1) E

階段部加工図 (柵・階段・梓材)

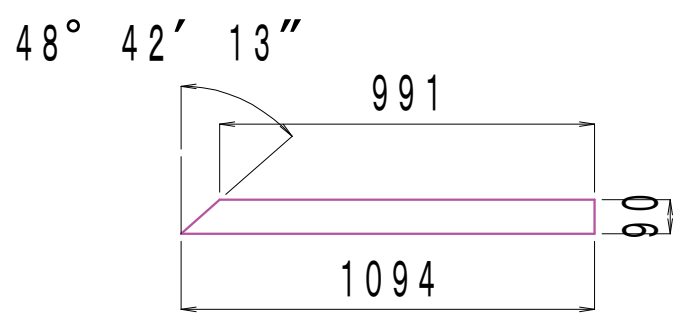

104: 38 × 89 × 1094 - 1 (2x4 1820 × 1) JAK

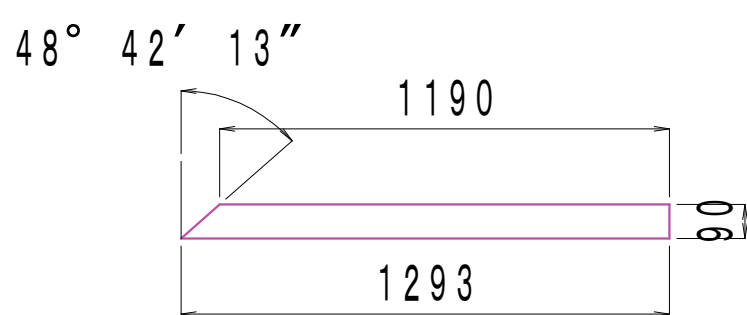

105: 38 × 89 × 1293 - 2 (2x4 1820 × 2) JAK

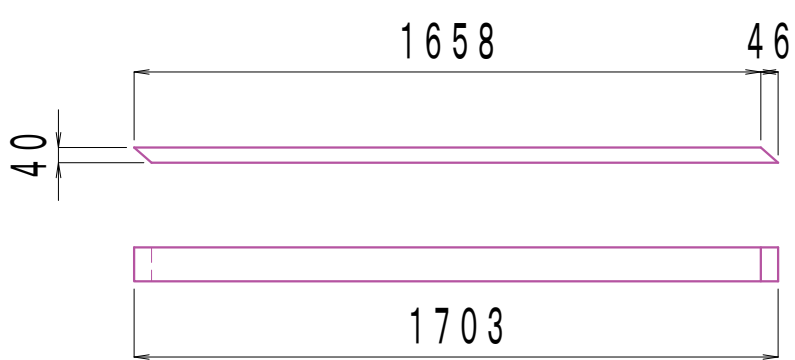

106: 38 × 89 × 1703 - 2 (2x4 1820 × 2) JAK

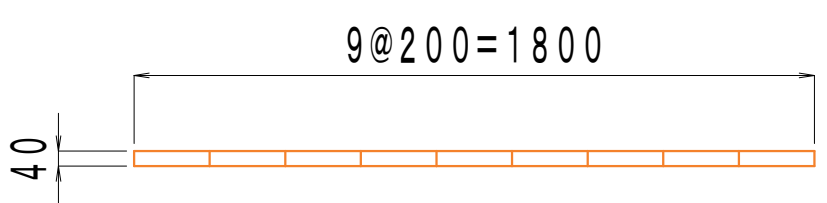

107: 40 × 40 × 200 - 24 (2x2 1800 × 3) E

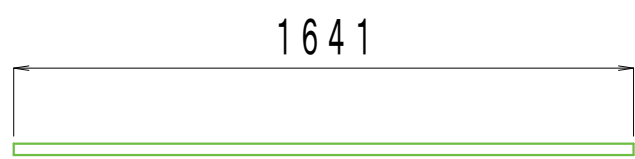

108: 40 × 30 × 1641 - 4 (2x2 1830 × 4) SPF

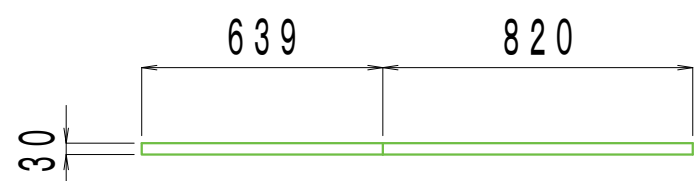

109: 40 × 30 × 639 - 2 (2x2 1830 × 2) SPF
110: 40 × 30 × 820 - 2 (2x2 -) SPF

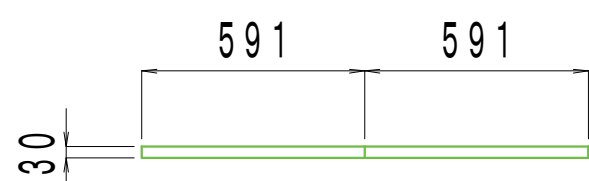

111: 40 × 30 × 591 - 2 (2x2 1830 × 1) SPF

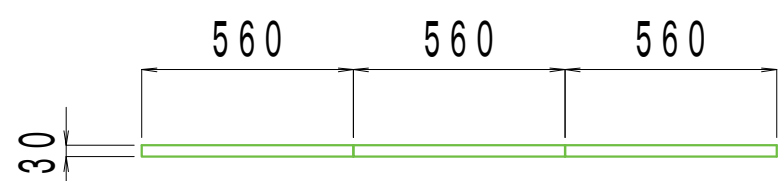

112: 40 × 30 × 560 - 20 (2x2 1830 × 7) SPF

