

12: 314 - 2 (MDF 450 × 300 × 5.5)

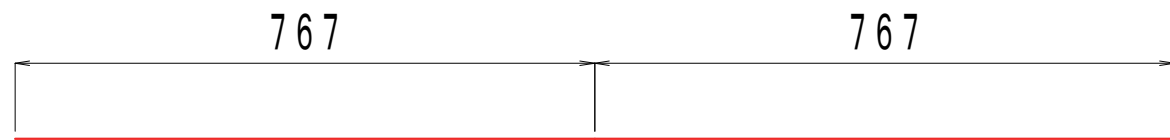

1: 767 - 8 (1820 × 4)

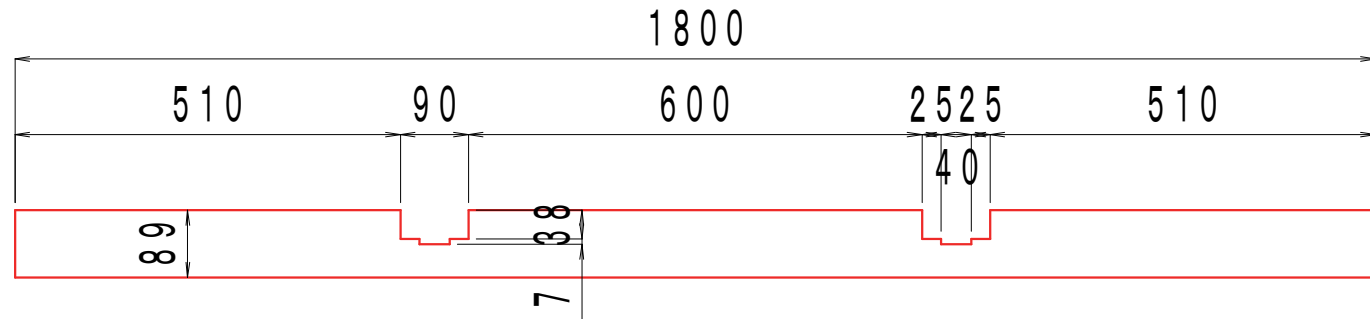

2: 1800 - 2 (1820 × 2)

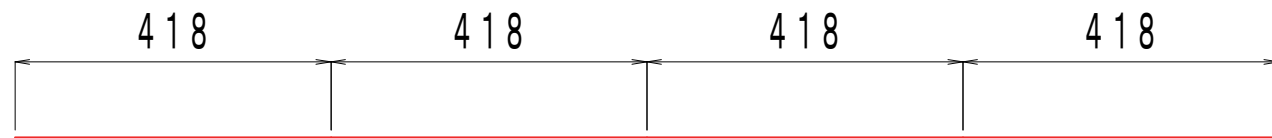

3: 418 - 12 (1820 × 3)

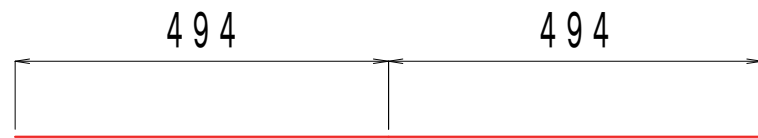

4: 494 - 2 (1820 × 1)

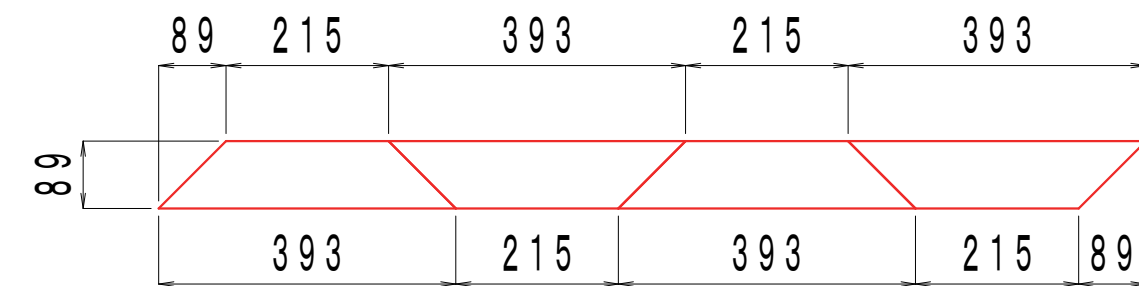

5: 393 - 4 (1820 × 1)

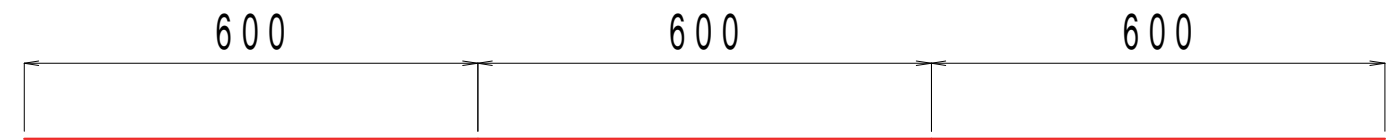

6: 600 - 18 (1820 × 6)

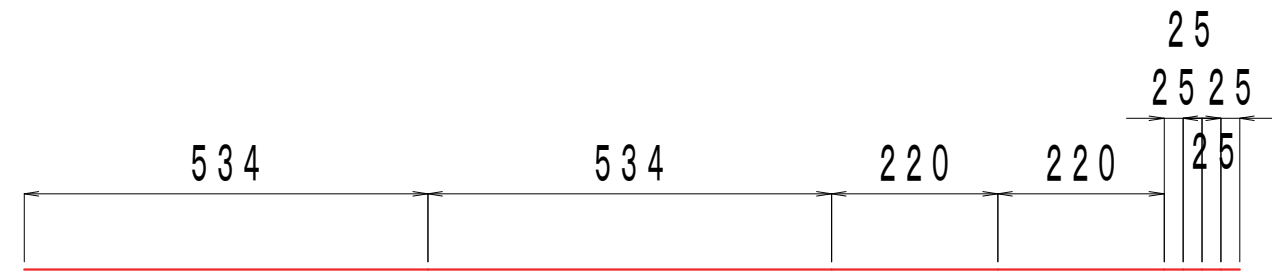

7: 534 - 2 (1820 × 1)

8: 220 - 2 (-)

11: 25 - 4 (-)

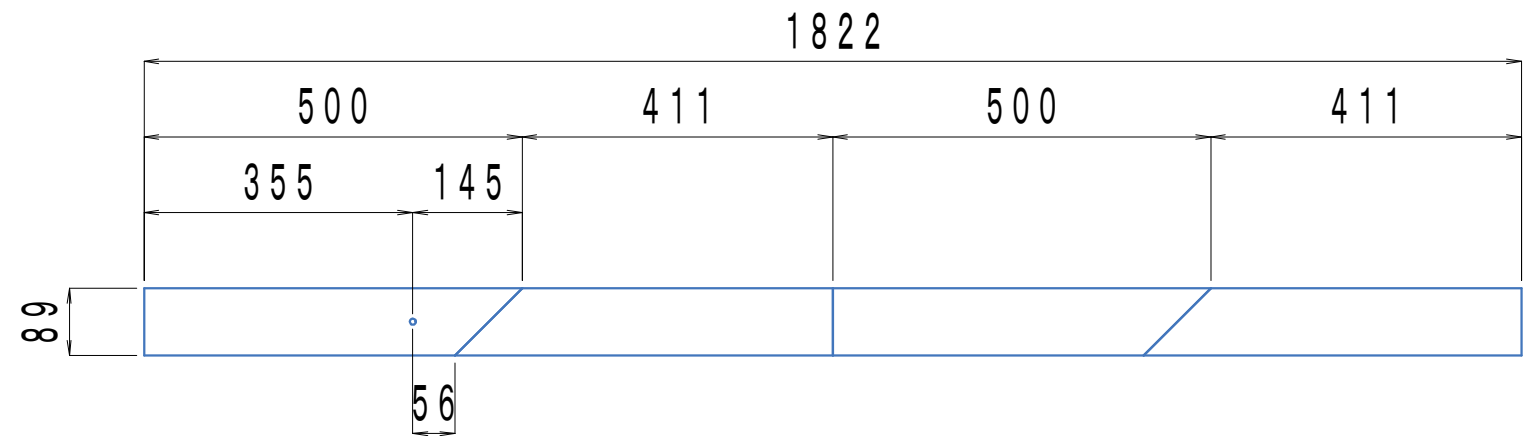

9: 500 - 6 (1820 × 2)

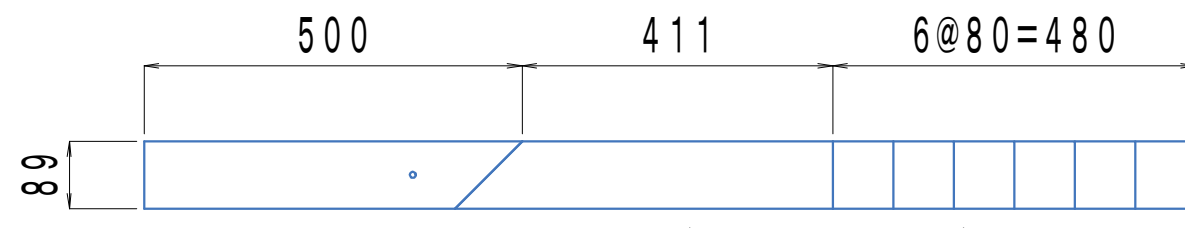

10: 80 - 6 (1820 × 2)

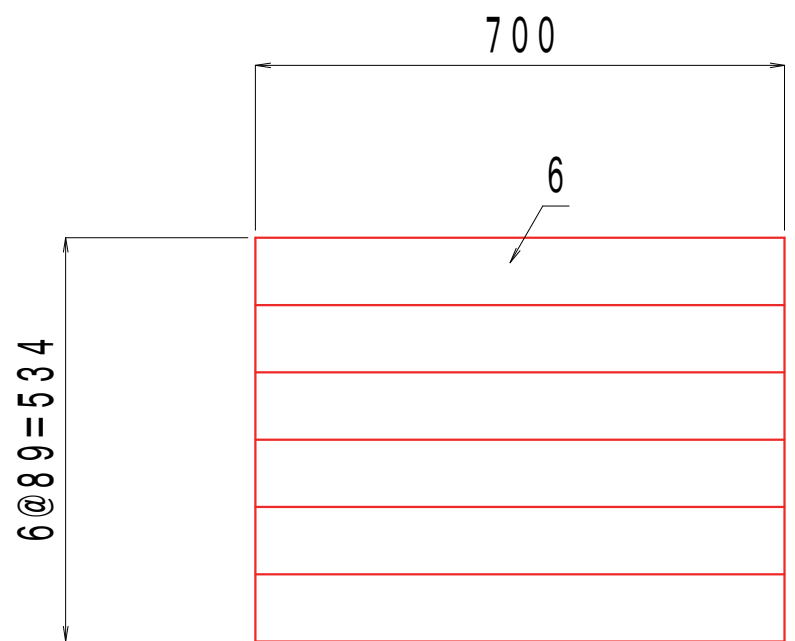
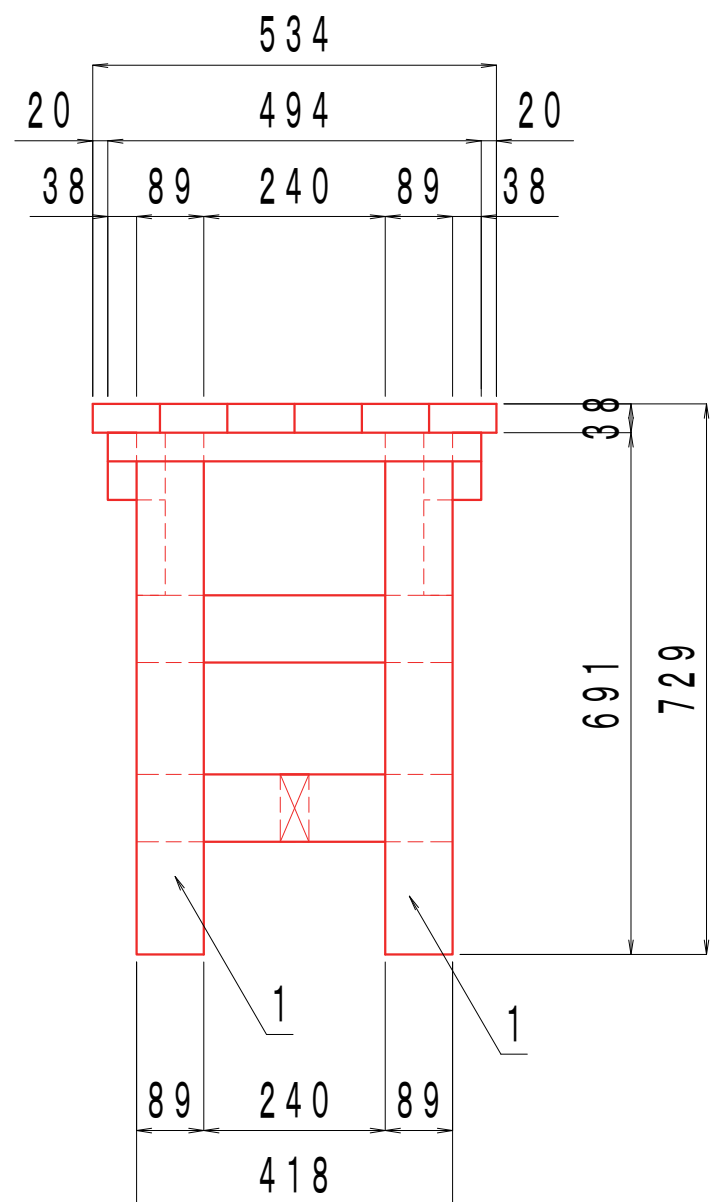
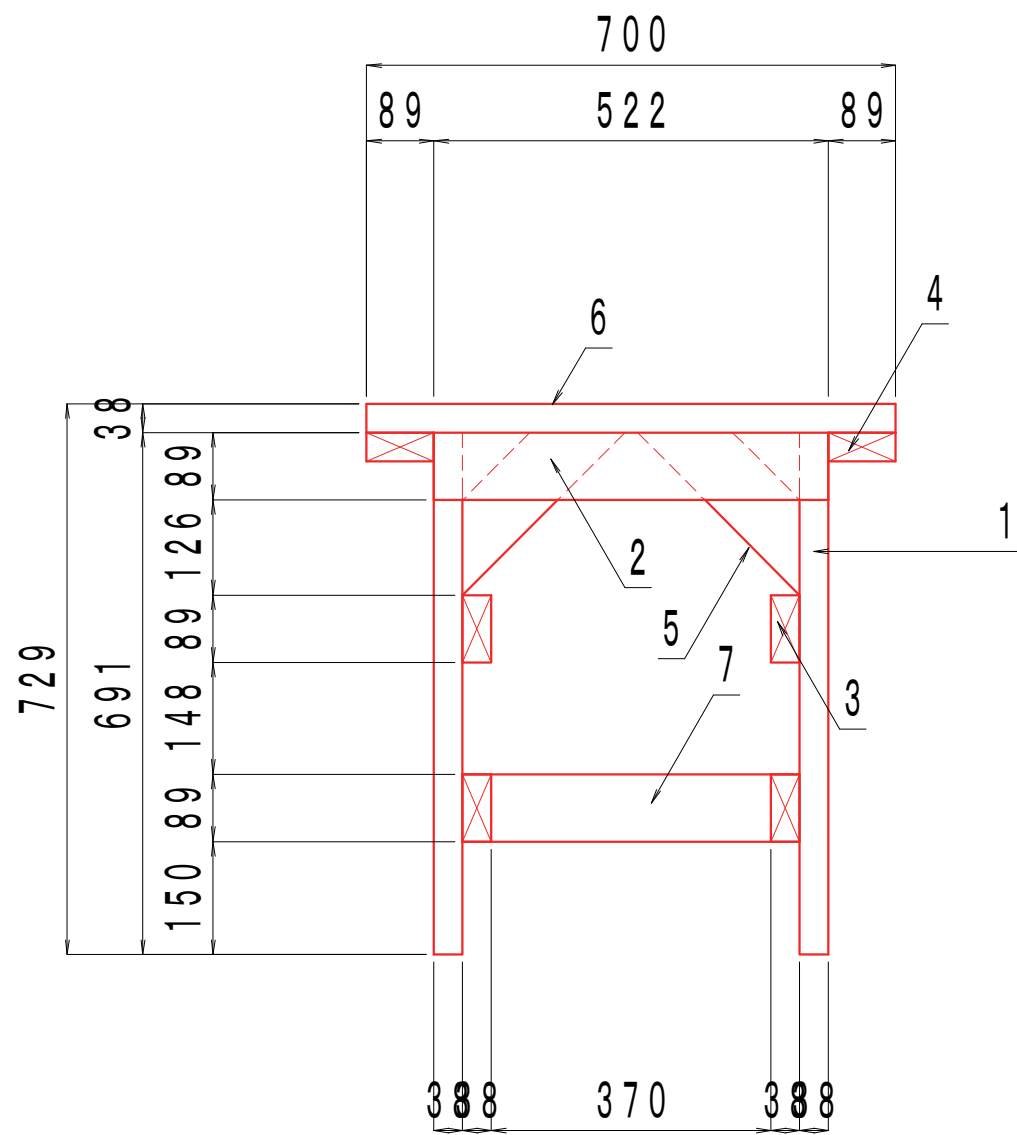

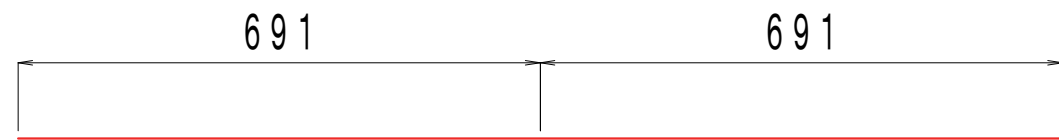

$$1: 691 - 4 \quad (1820 \times 2)$$

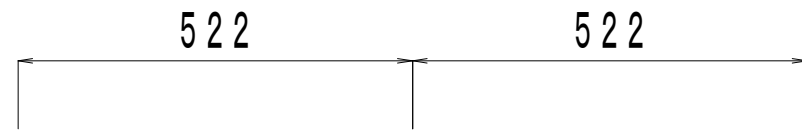

$$2: 522 - 2 \quad (1820 \times 1)$$

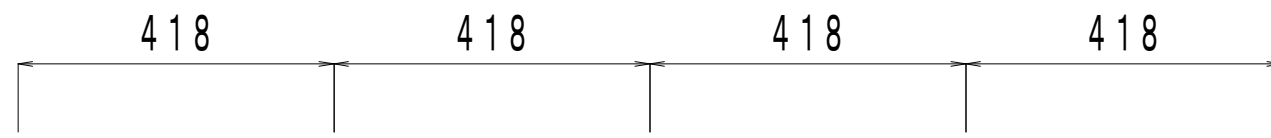

$$3: 418 - 4 \quad (1820 \times 1)$$

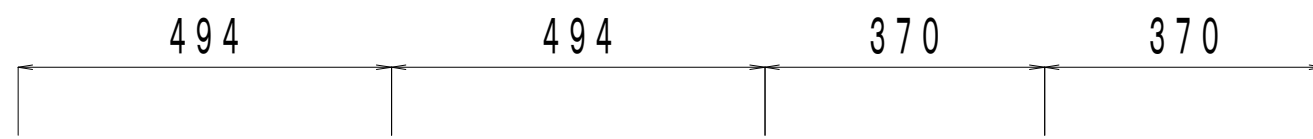

$$4: 494 - 2 \quad (1820 \times 1)$$

$$7: 370 - 2 \quad (-)$$

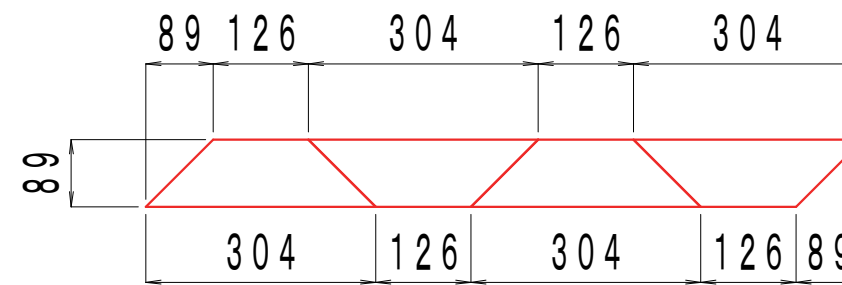

$$5: 304 - 4 \quad (1820 \times 1)$$

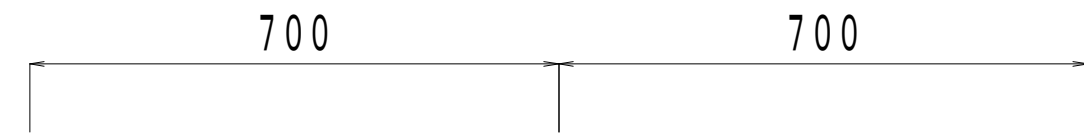

$$6: 700 - 6 \quad (1820 \times 3)$$

SPF 2 × 4 1820mm N=29

258 × 29 = 7,482円